

# Extrinsic Symmetric Spaces

Jost Eschenburg (University of Augsburg, Germany)\*

July 5, 2017

## Contents

1. Submanifolds with $\nabla\alpha = 0$ are extrinsic symmetric.	1
2. Extrinsic symmetric spaces (ESS) split extrinsically.	2
3. The indecomposable ESS.	3
4. ESS are certain isotropy orbits of symmetric spaces.	5
5. How to classify ESS.	7
6. ESS are real forms of hermitian symmetric spaces.	8
7. ESS are midpoint components between center elements.	10
8. Maximal tori of ESS are products of planar circles.	12
9. Isometries of ESS are extrinsic.	14
10. ESS have a noncompact transformation group.	16
11. ESS contain their noncompact duals.	18
12. ESS in symmetric spaces come from ESS in euclidean space.	19

## 1. Submanifolds with $\nabla\alpha = 0$ are extrinsic symmetric.

The local invariant which distinguishes Riemannian from euclidean geometry is the curvature tensor  $R$  of a Riemannian manifold  $M$ . Therefore, spaces where  $R$  is “constant” ( $\nabla R = 0$ ) are of fundamental importance for Riemannian geometry. These are the *locally symmetric spaces*: for any  $x \in M$ , the *geodesic symmetry*  $s_x : \exp_x(v) \mapsto \exp_x(-v)$  (reversing every geodesic  $\gamma$  with  $\gamma(0) = x$ ) is an isometry near  $x$ . In fact, due to  $\nabla R = 0$ , the Jacobi equation for geodesic variations of  $\gamma$  has constant coefficients with respect to a parallel frame along  $\gamma$ . Therefore a Jacobi field  $J$  along  $\gamma$  with  $J(0) = 0$  is odd,  $J(-t) = -J(t)$ , and hence the differential  $(s_x)_*$  with  $(s_x)_*J(t) = J(-t)$  preserves the length of vectors.

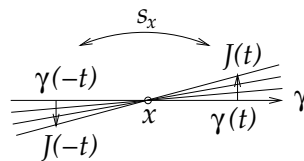

Vice versa, if the geodesic reflection  $s_x$  happens to be a local isometry, then  $(s_x)_*\nabla R = (s_x)^*\nabla R$  (where  $\nabla R : (T_x M)^{\otimes 4} \rightarrow T_x M$ ), but  $(s_x)^*\nabla R = \nabla R$  since  $(s_x)^*$  changes sign in each of the four slots of  $\nabla R$  while  $(s_x)_*\nabla R = -\nabla R$ . Thus  $\nabla R = 0$ .

If a Riemannian manifold  $M$  is isometrically immersed into euclidean space  $V = \mathbb{R}^n$ , its second fundamental form  $\alpha : TM \otimes TM \rightarrow NM$  is like a square root of  $R$ , according to Gauss equations  $R = \alpha \wedge \alpha$ . From this view point, spaces where this “square root” is constant, submanifolds with  $\nabla\alpha = 0$ , seem even more fundamental. Obviously,  $\nabla\alpha = 0$  implies  $\nabla R = 0$ , but in fact much more is true:

---

2000 Mathematics Subject Classification: 53C35, 53C40, 53C55.

Keywords: parallel second fundamental form, s-orbits, real forms, midpoints.

\* e-mail: [eschenburg@math.uni-augsburg.de](mailto:eschenburg@math.uni-augsburg.de)

web: <http://myweb.rz.uni-augsburg.de/~eschenbu/>

**Theorem 1.** [27] *Let  $M \subset V = \mathbb{R}^n$  be a complete submanifold. Then  $\nabla\alpha = 0$  if and only if  $M$  is extrinsic symmetric: It is invariant under the reflections  $r_x$  along each of its affine normal space  $N_x + x$  of  $M$ .*

*Proof.* The proof due to Strübing [27]<sup>1</sup> is similar to the argument above, but now we have an ODE not just for geodesic variation fields  $J$  but for every single geodesic  $\gamma$  with  $\gamma(0) = x$ . We choose parallel tangent and normal orthonormal frames  $E = (E^T, E^N) = (e_1, \dots, e_m, e_{m+1}, \dots, e_n)$  along  $\gamma$  with  $\gamma' = e_1$ . Then  $E$  satisfies a first order linear ODE with constant coefficients of the type

$$E' = EA \quad (1)$$

where  $A$  contains the coefficients of  $\alpha$ , expressed in the parallel basis  $E$ . Due to  $\nabla\alpha = 0$ , the matrix  $A$  is constant, and moreover  $A = \begin{pmatrix} B & C \end{pmatrix}$  for some constant linear map  $B : T \rightarrow N$  (given by  $Be_i = \sum_{\beta} \langle \alpha(e_1, e_i), e_{\beta} \rangle e_{\beta}$ ), where  $-C : N \rightarrow T$  is the transposed of  $B$ . We claim

$$r_x E(t) = E(-t)S \quad (2)$$

where  $S = \begin{pmatrix} -I & \\ & I \end{pmatrix}$ . Let us put  $\tilde{E}(t) = E(-t)$ . Then from (1),

$$\tilde{E}' = -\tilde{E}A. \quad (3)$$

Now we see that both sides of (2),  $r_x E$  and  $\tilde{E}S$ , satisfy the same ODE (1):

$$\begin{aligned} (r_x E)' &= r_x E' \stackrel{(1)}{=} r_x EA = (r_x E)A, \\ (\tilde{E}S)' &= \tilde{E}'S \stackrel{(3)}{=} -\tilde{E}AS = (\tilde{E}S)A \end{aligned}$$

since  $S = \begin{pmatrix} -I & \\ & I \end{pmatrix}$  and  $A = \begin{pmatrix} B & C \end{pmatrix}$  anticommute. Moreover, both sides have the same initial value at  $t = 0$ , so they agree. In particular, for  $e_1 = \gamma'$  we have  $r_x \gamma'(t) = -\gamma'(-t)$  and by integration,  $r_x \gamma(t) = \gamma(-t)$ . Thus  $r_x(M) = M$ , and  $r_x|_M$  is the geodesic reflection  $s_x$  at  $x$  in  $M$ .

Vice versa, an extrinsic symmetric submanifold  $M$  satisfies  $\nabla\alpha = 0$ : since  $r_x$  is an extrinsic isometry for any  $x \in M$ , we have  $(r_x)_* \nabla\alpha = (r_x)^* \nabla\alpha$  where  $\nabla\alpha : TM^{\otimes 3} \rightarrow NM$ . But  $(r_x)_* \nabla\alpha = \nabla\alpha$  (the values of  $\nabla\alpha$  are in  $N_x$ ) while  $(r_x)^* \nabla\alpha = -\nabla\alpha$  (all three slots of  $\nabla\alpha$  receive a minus sign), thus  $\nabla\alpha = 0$ .  $\square$

## 2. Extrinsic symmetric spaces (ESS) split extrinsically.

Since the mean curvature vector  $H = \text{trace } \alpha$  is parallel, its shape operator<sup>2</sup>  $A_H$  is also parallel and  $[A_H, A_{\xi}] = 0$  for any  $\xi \in NM$ , due to the Ricci equation.<sup>3</sup> Thus the eigenspaces of  $A_H$  form parallel  $A_{\xi}$ -invariant distributions  $E_i$  on  $M$  with  $\alpha(E_i, E_j) = 0$  for  $i \neq j$ . Thus (using Moore's theorem) we obtain an extrinsic splitting where the tangent bundles of the factors are the distributions  $E_i$ . The factor  $M_0$  corresponding the kernel of  $A_H$  is minimal, hence it is an affine subspace of  $V$ , by the subsequent Lemma 1. Thus we have shown:

<sup>1</sup> See also [2] for a general reference.

<sup>2</sup> For any  $\xi \in N_x M$ , the *shape operator*  $A_{\xi}$  is defined by  $\langle A_{\xi} v, w \rangle = \langle \alpha(v, w), \xi \rangle$  for all  $v, w \in T_x M$ .

<sup>3</sup> The curvature tensors  $R^T$  of the tangent bundle  $TM$  and  $R^N$  of the normal bundle  $NM$  both are related to the second fundamental form,  $R_{abcd}^T = \alpha_{ad}\alpha_{bc} - \alpha_{ac}\alpha_{bd}$  (Gauss equation) and  $R_{\xi, \eta}^N = -[A_{\xi}, A_{\eta}]$  (Ricci equation). Since  $H$  is parallel, we have  $R_{\xi, H}^N = 0$  for any  $\xi \in N$ , thus  $[A_{\xi}, A_H] = 0$ .

**Theorem 2.** *Extrinsic symmetric spaces  $M \subset V = \mathbb{R}^n$  split as*

$$M = V_0 \times M_1 \times \dots \times M_s \quad (4)$$

where  $V = V_0 \oplus V_1 \cdots \oplus V_s$  and  $M_i \subset V_i$  is extrinsic symmetric. Further,  $H = \sum_i H_i$  where  $H_i$  is the mean curvature vector of  $M_i \subset V_i$ , and  $A_{H_i} = \lambda_i I$  for some  $\lambda_i \neq 0$ .

**Lemma 1.** *Let  $K/K_+ \cong M \subset V$  extrinsic symmetric and minimal. Then  $M$  is an affine subspace.*

*Proof.* Consider the equivariant map (Gauss map)  $\tau : x \mapsto T_x M : M \rightarrow G_m(V)$  where  $G_m(V)$  is the Grassmannian of  $m$ -planes in  $V$ ,  $m = \dim M$ . We may assume that  $M$  is indecomposable and full (no extra codimension). If  $M \subset V$  is an affine subspace,  $M = V$   $\tau$  maps  $M$  onto the single element  $V \in G_m(V)$ . Otherwise,  $\tau$  is an equivariant immersion and hence an isometry (up to some dilatation) on each irreducible local factor of  $M$  since there is only one  $K_+$ -invariant metric on an irreducible factor of the tangent space. But  $\tau(M) \subset G_m(V)$  is invariant under all the symmetries  $s_{\tau(x)}$ ,  $x \in M$ , of  $G_m(V)$  and hence it is totally geodesic.<sup>4</sup> In particular,  $M$  has sectional curvature  $\geq$  since each irreducible local factor is totally geodesically immersed into the symmetric space  $G_m(V)$  of compact type. But on the other hand,  $M \subset V$  is a minimal submanifold which implies that  $M$  has some negative sectional curvatures unless it is an affine subspace, see Lemma 2 below. This finishes the proof.  $\square$

**Lemma 2.** *The scalar curvature of a minimal submanifold  $M \subset V$  is nonpositive and it is everywhere zero only if  $M$  is an affine subspace.*

*Proof.* Fix some  $x \in M$ . Let  $(\xi_\alpha)$  be an orthonormal basis of the normal space  $N$  at  $x$  and put  $A^\alpha = A_{\xi_\alpha}$  with matrix coefficients  $A_{ij}^\alpha = \langle A^\alpha e_i, e_j \rangle$  for some orthonormal basis of the tangent space  $T$  at  $x$ . We compute the scalar curvature via the Gauss equation:

$$s = \sum_{i < j} \langle R(e_i, e_j)e_j, e_i \rangle = \sum_{\alpha} \sum_{i < j} (A_{ii}^\alpha A_{jj}^\alpha - (A_{ij}^\alpha)^2) .$$

For any  $\alpha$  we choose a different orthonormal basis  $(e_i)$  of  $T$ , consisting of eigenvectors of  $A^\alpha$ . Denoting by  $\lambda_i^\alpha$  the eigenvalues of  $A^\alpha$  and putting  $\vec{\lambda}^\alpha = (\lambda_1^\alpha, \dots, \lambda_m^\alpha)$ , the right hand side simplifies:

$$s = \sum_{\alpha} \sum_{i < j} \lambda_i^\alpha \lambda_j^\alpha = \sum_{\alpha} \epsilon_2(\vec{\lambda}^\alpha)$$

where  $\epsilon_2$  denotes the second elementary symmetric polynomial. Since  $M$  is minimal, we have trace  $A^\alpha = 0$ , thus the first elementary symmetric polynomial vanishes,  $\epsilon_1(\vec{\lambda}^\alpha) = \sum_i \lambda_i^\alpha = 0$ . But  $(\epsilon_1)^2 = \pi_2 + 2\epsilon_2$  where  $\pi_2(\vec{\lambda}) = \sum(\lambda_i)^2$ . Thus

$$\epsilon_2(\vec{\lambda}^\alpha) = -\pi_2(\vec{\lambda}^\alpha)/2 \leq 0 ,$$

and equality happens only if all  $\lambda_i^\alpha = 0$ , this means all  $A^\alpha = 0$  and thus  $M$  is an (open part of an) affine subspace.  $\square$

### 3. The indecomposable ESS.

**Theorem 3.** *The list of indecomposable extrinsic symmetric spaces is as follows.<sup>5</sup>*

<sup>4</sup>In fact, if  $P$  is a symmetric space and  $Q \subset P$  invariant under all symmetries  $s_q$ ,  $q \in Q$ , then  $Q$  is totally geodesic: if  $\beta$  denotes the second fundamental form of  $Q \subset P$  at some point  $q \in Q$ , we have  $(s_q)_* \beta(v, w) = \beta((s_q)_* v, (s_q)_* w)$  for all  $v, w \in T_q Q$ , but  $(s_q)_* = -I$ , so the left hand side is  $-\beta(v, w)$  while the right hand side is  $+\beta(v, w)$ . Thus  $\beta = 0$ , that is  $Q \subset P$  is totally geodesic.

<sup>5</sup>This list can be found at several places, see e.g. [2, p.311] or [11].

- hermitian (Kähler) symmetric spaces,
- classical groups  $SO_n, U_n, Sp_n$ ,
- real and quaternionic Grassmannians  $G_p(\mathbb{R}^n), G_p(\mathbb{H}^n)$ ,
- real and quaternionic structures on  $\mathbb{C}^n, U_n/O_n$  and  $U_n/Sp_{n/2}$ ,
- spheres and twisted sphere products  $(\mathbb{S}^p \times \mathbb{S}^q)/\pm, q \geq 0$ ,
- four exceptional examples:  $(SU_8/Sp_4)/\mathbb{Z}_2, \mathbb{S}^1 \cdot E_6/F_4, G_2(\mathbb{H}^4)/\mathbb{Z}_2, \mathbb{O}\mathbb{P}^2$ .

As explained before, a *symmetric space*  $M$  is a Riemannian manifold where the scalar multiplication by  $-1$  on every tangent space  $T_x M$  extends to a global isometry  $s_x$ . A *hermitian symmetric space*  $M = G/H$  is a Kähler manifold<sup>6</sup> where the scalar multiplication on  $T = T_x M$  by *any* complex unit scalar (not just by  $-1$ ) extends to a global isometry on  $M$ . Thus we obtain a circle group  $\mathbb{S}_x^1 \subset G_x = H$  acting on  $T$  by complex multiples of the unit matrix. These commute with the action of any  $h \in H$  on  $T$  (see footnote 6), hence  $\mathbb{S}_x^1$  belongs to the center of  $H$ .<sup>7</sup> Let  $\hat{x} \in \mathfrak{h} \subset \mathfrak{g}$  be the canonical generator of  $\mathbb{S}_x^1$ . The extrinsic symmetric embedding (*standard embedding*) is the map  $M \ni x \mapsto \hat{x} \in \mathfrak{g} =: V$ . This is  $G$ -equivariant where  $G$  acts on  $\mathfrak{g}$  by the adjoint representation  $\text{Ad}$ . The decomposition  $\mathfrak{g} = T + N$  into tangent and normal spaces of  $M$  with  $T = [\mathfrak{g}, x]$  and  $N = [\mathfrak{g}, x]^\perp = \{\xi : [x, \xi] = 0\} = \mathfrak{h}$  equals the Cartan decomposition  $\mathfrak{g} = \mathfrak{m} + \mathfrak{h}$  corresponding to the symmetric space  $M = G/H$ . The extrinsic symmetry is the Cartan involution  $\sigma$  which is the adjoint action by the symmetry  $s_x$  at  $x = eH$ . Further,  $J_x := \text{ad}_{\hat{x}}$  is the complex structure on  $T = \mathfrak{m}$  and it vanishes on  $N = \mathfrak{h}$ .<sup>8</sup> Here are the hermitian symmetric spaces:

- Grassmannians of oriented real 2-planes  $G_2^+(\mathbb{R}^{n+2}) = \text{quadric in } \mathbb{C}\mathbb{P}^{n+1}$ ,
- complex Grassmannians  $G_p(\mathbb{C}^n)$ ,
- complex structures on  $\mathbb{R}^{2n}$  and  $\mathbb{H}^n, SO_{2n}/U_n$  and  $Sp_n/U_n$ ,
- two exceptional examples:  $E_7/(\mathbb{S}^1 \cdot E_6), E_6/(\mathbb{S}^1 \cdot Spin_{10})$ .

The extrinsic symmetric embeddings  $M \subset V$  for the non-hermitian examples are as follows. The *groups*  $SO_n, U_n, Sp_n$  are contained in their corresponding matrix spaces  $V = \mathbb{K}^{n \times n}$  for  $\mathbb{K} = \mathbb{R}, \mathbb{C}, \mathbb{H}$ . The elements of *Grassmannians* are  $\mathbb{K}$ -linear subspaces of  $\mathbb{K}^n$ , and replacing any subspace  $E$  by the orthogonal projection  $\pi_E$  onto  $E$ , we embed the Grassmannian into the space  $V = S(\mathbb{K}^n)$  of symmetric or hermitian matrices over  $\mathbb{K} = \mathbb{R}$  or  $\mathbb{K} = \mathbb{H}$ .<sup>9</sup> *Real and quaternionic structures* on  $\mathbb{C}^n$  are certain elements (those which square to  $\pm I$ ) of the vector space  $V$  of complex-antilinear maps which are symmetric or antisymmetric, respectively. The *twisted sphere products*  $(\mathbb{S}^p \times \mathbb{S}^q)/\pm$  are embedded into  $V = \mathbb{R}^{p+1} \otimes \mathbb{R}^{q+1}$  as the subset  $\mathbb{S}^p \otimes \mathbb{S}^q$ ; note that  $(-v) \otimes (-w) = v \otimes w$ .

<sup>6</sup> A *Kähler manifold* is a Riemannian manifold  $M$  with an orthogonal almost complex structure  $J$  on  $TM$  (making each tangent space  $T_x M$  a complex vector space) which is parallel,  $\nabla J = 0$ . Each isometry maps  $J$  onto another parallel complex structure, but if  $M$  is irreducible, there are just  $J$  and  $-J$  (only exception: hyper-Kähler manifolds, but those are never symmetric), thus the identity component of the isometry group consists of *holomorphic* isometries.

<sup>7</sup> In fact by Schur's lemma,  $\mathbb{S}_x^1$  equals the center of  $H$  when  $P$  is irreducible.

<sup>8</sup> All this can be seen nicely in the example  $M = \mathbb{S}^2 \subset \mathbb{R}^3 = \mathfrak{so}_3$  where  $J_x v = x \times v = \text{ad}_x v$ .

<sup>9</sup> Essentially the same holds also for  $\mathbb{K} = \mathbb{C}$ . In fact, reflections are hermitian matrices, and the Lie algebra  $\mathfrak{u}_n$  of  $U_n$  also consists of hermitian matrices, up to a factor  $i$ . Let  $M = G_p(\mathbb{C}^n) = U_n/(U_p \times U_{n-p})$  be the Grassmannian of  $p$ -dimensional subspaces of  $\mathbb{C}^n$  with its standard embedding into  $\mathfrak{u}_n$ . Consider a subspace  $E \in G_p(\mathbb{C}^n)$ . We have  $T = T_E M = \begin{pmatrix} * & * \\ & * \end{pmatrix} \cap \mathfrak{u}_n$  and  $N = N_E M = \begin{pmatrix} * & * \\ & * \end{pmatrix} \cap \mathfrak{u}_n$  with respect to the decomposition  $\mathbb{C}^n = E + E^\perp$ , for any  $E \in M$ . The generator  $J = J_E$  of the circle group  $\mathbb{S}_E^1$  is the complex structure on  $T$  and zero on  $N$ , and this is  $J = \begin{pmatrix} i & \\ & 0 \end{pmatrix} = i\pi_E$ , acting on  $\mathfrak{u}_n$  by  $\text{ad}$ . Even for the octonions  $\mathbb{K} = \mathbb{O}$ , this embedding by projections survives for  $\mathbb{O}\mathbb{P}^2 = G_1(\mathbb{O}^3)$ , see next footnote 10.

The four *exceptional examples* are embedded in the Lie triples (see footnote 11)  $V = \mathfrak{p}$  corresponding to the exceptional symmetric spaces  $P = E_7/SU_8, E_7/U_1E_6, E_6/Sp_4, E_6/F_4$ , respectively.<sup>10</sup>

#### 4. ESS are certain isotropy orbits of symmetric spaces.

Let  $M \subset \mathbb{S}^{n-1} \subset V = \mathbb{R}^n$  be an indecomposable ESS. The extrinsic isometry group  $\hat{K} = \{A \in O_n : A(M) = M\}$  and its connected component  $K = \hat{K}^o$  act transitively on  $M$ . Hence  $M$  is the orbit of an orthogonal representation of  $K$  on  $V$ . According to Dirk Ferus [14], this is a so called *s-representation*, the isotropy representation of another symmetric space  $P = G/K$ . In other words,  $V$  carries the structure of a Lie triple,<sup>11</sup> and  $M$  is an orbit of the connected component  $K$  of its automorphism group. More precisely,  $M = \text{Ad}_K x$  for some  $x \in V$  with  $(\text{ad}_x)^3 = -\text{ad}_x$ . Ferus used the theory of Jordan triple systems; here we sketch a more elementary argument taken from [12, 17].

Given a  $K$ -orbit  $M \subset V$  with  $x \in M$ , let  $T = T_x M$  and  $N = N_x M = T^\perp$ . The Lie algebra  $\mathfrak{k}$  of  $K$  decomposes as  $\mathfrak{k} = \mathfrak{k}_+ \oplus \mathfrak{k}_-$  where  $\mathfrak{k}_+$  is the Lie algebra of the isotropy group  $K_+ = \{k \in K : kx = x\}$  and  $\mathfrak{k}_-$  an  $\text{Ad}_K$ -invariant vector space complement. As usual,  $\mathfrak{k}_-$  can be identified with  $T$  using the differential of the map  $k \mapsto kx$ , restricted to  $\mathfrak{k}_-$ . We choose an  $\text{Ad}_K$ -invariant inner product on  $\mathfrak{k}$  with  $\mathfrak{k}_+ \perp \mathfrak{k}_-$  and such that the isomorphism  $\mathfrak{k}_- \rightarrow T$  is an isometry.<sup>12</sup> Now for any  $x, y \in V$  we define a ‘‘Lie bracket’’  $[x, y] \in \mathfrak{k}$  by its inner product with any  $A \in \mathfrak{k}$ :

$$\langle A, [x, y] \rangle := \langle Ax, y \rangle. \quad (5)$$

So far we haven’t used that the orbit  $M = Kx$  is extrinsic symmetric. But we have to show the *Jacobi identity* for this ‘‘Lie bracket’’, the vanishing of the expression  $\text{Jac}(x, y, z) := [[x, y], z] + [[y, z], x] + [[z, x], y]$ .<sup>13</sup> For this we will use that  $T$  and  $N$  are preserved by  $\mathfrak{k}_+$  and reversed by  $\mathfrak{k}_-$ ,

$$\mathfrak{k}_+ = (* *) \cap \mathfrak{k}, \quad \mathfrak{k}_- = (* *) \cap \mathfrak{k} \quad (6)$$

This is a direct consequence of the definition of an extrinsic symmetric space: the extrinsic symmetries  $r_x, x \in M$  reverse parallel tangent vector fields along any geodesic  $\gamma$  with  $\gamma(0) = x$ , while parallel normal fields along  $\gamma$  are preserved. Thus the *transvections*  $k_t = r_y r_x$  for  $y = \gamma(t/2)$  shift the parameter of  $\gamma$  by  $t$  and act as tangent and normal parallel displacements along  $\gamma$ .

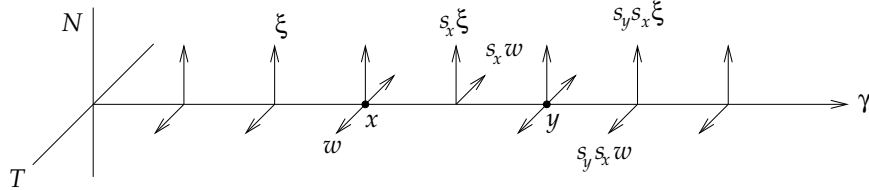

<sup>10</sup>In the last case we have  $V = S(\mathbb{O}^3)$ , the space of hermitian  $3 \times 3$ -matrices over  $\mathbb{O}$ , and  $M \subset V$  is the subset of idempotents with trace one, like projections onto one-dimensional subspaces.

<sup>11</sup>A *Lie triple* is a euclidean vector space  $V = \mathfrak{p}$  with a Lie triple product, that is a symmetric curvature tensor  $R : V^{\otimes 3} \rightarrow V$ ; ‘‘symmetric’’ means the additional property that  $R(v, w) : V \rightarrow V$  is a derivation of  $R$  for any  $v, w \in V$ . Élie Cartan observed that any Lie triple extends to a Lie algebra  $\mathfrak{g} = \mathfrak{p} \oplus \mathfrak{k}$  where  $\mathfrak{k}$  is the Lie algebra of derivations of  $R$  and the Lie bracket on  $\mathfrak{g}$  for  $v, w \in \mathfrak{p}$  and  $A \in \mathfrak{k}$  is given by  $[A, v] = Av$  and  $[v, w] = \mp R(v, w)$  while  $\mathfrak{k} \subset \mathfrak{g}$  is a subalgebra. Then  $\mathfrak{g}$  is a Lie algebra and  $(\mathfrak{g}, \mathfrak{k})$  a symmetric pair corresponding to a symmetric space  $P = G/K$ .

<sup>12</sup>Such metric exists for sure when  $M$  is symmetric and  $K$  its transvection group. Then  $\mathfrak{k}_+ = [\mathfrak{k}_-, \mathfrak{k}_-]$  and the metric on  $\mathfrak{k}_+$  is again defined by  $\langle A, [x, y] \rangle = \langle Ax, y \rangle$  for all  $A \in \mathfrak{k}_+$  and  $x, y \in \mathfrak{k}_-$ , cf. [17].

<sup>13</sup>If this ‘‘Lie bracket’’  $V \otimes V \rightarrow \mathfrak{k}$  is viewed as a curvature tensor (see footnote 11), the Jacobi identity becomes the first Bianchi identity.

The generator of this transvection group (“*infinitesimal transvection*”) is the derivative of parallel tangent or normal fields which has zero tangent or normal component, and the surviving part of the derivative is the second fundamental form: For  $v = \gamma'(0)$  we have  $\frac{d}{dt}\big|_{t=0} k_t = S_v$ , where

$$S_v w = \alpha(v, w), \quad S_v \xi = -A_\xi v \quad (7)$$

(see footnote 2) for all  $v, w \in T$  and  $\xi \in N$ . Obviously, the infinitesimal transvections reverse  $T$  and  $N$  and they form a complement  $\mathfrak{k}_-$  to  $\mathfrak{k}_+$ . Moreover we have seen that  $\mathfrak{k}_-$  is closely related to the second fundamental form:  $\mathfrak{k}_- = \{S_v : v \in T\}$ , and the linear map  $v \mapsto S_v: T \rightarrow \mathfrak{k}_-$  is an isomorphism with inverse map  $S_v \mapsto S_v x = -A_x v = v$ .

For the “Lie bracket” this means  $[T, T] \subset \mathfrak{k}_+$ ,  $[N, N] \subset \mathfrak{k}_+$ ,  $[T, N] \subset \mathfrak{k}_-$  since  $\langle \mathfrak{k}_+, [T, N] \rangle = \langle \mathfrak{k}_+ T, N \rangle = \langle T, N \rangle = 0$  and similar for the other cases. More precisely, for any  $v, w \in T$  and  $\xi, \eta \in N$  we have

$$\begin{aligned} [v, w] &= [S_v, S_w] \in \mathfrak{k}_+, \\ [v, \xi] &= S_{A_\xi v} \in \mathfrak{k}_-, \\ [\xi, \eta] &= -[A_\xi, A_\eta] \in \mathfrak{k}_+. \end{aligned} \quad (8)$$

In fact, for any  $A \in \mathfrak{k}_+$  we have:<sup>14</sup>

$$\begin{aligned} \langle A, [v, w] \rangle &= \langle Av, w \rangle = \langle S_{Av}, S_w \rangle = \langle [A, S_v], S_w \rangle = \langle A, [S_v, S_w] \rangle, \\ \langle S_w, [v, \xi] \rangle &= \langle S_w v, \xi \rangle = \langle \alpha(w, v), \xi \rangle = \langle w, A_\xi v \rangle = \langle S_w, S_{A_\xi v} \rangle, \\ \langle [\xi, \eta] v, w \rangle &= \langle [\xi, \eta], [v, w] \rangle = \langle [\xi, \eta], [S_v, S_w] \rangle = \langle [S_v, S_w] \xi, \eta \rangle = -\langle [A_\xi, A_\eta] v, w \rangle. \end{aligned}$$

Thus the Jacobi identities on  $T$  and  $N$  follow from the identities for the matrices  $S_v$  and  $A_\xi$ . The remaining Jacobi identities,  $\langle Jac(v, w, \xi), \eta \rangle, \langle Jac(v, \xi, \eta), w \rangle = 0$  follow from

$$\langle S_{(A_\xi v)} \eta, w \rangle = -\langle A_\eta A_\xi v, w \rangle = -\langle A_\xi v, A_\eta w \rangle = -\langle S_v \xi, S_w \eta \rangle = \langle S_w S_v \xi, \eta \rangle.$$

In fact:

$$\begin{aligned} \langle [v, w] \xi, \eta \rangle + \langle [w, \xi] v, \eta \rangle + \langle [\xi, v] w, \eta \rangle &= \langle [S_v, S_w] \xi, \eta \rangle + \langle S_{A_\xi w} v, \eta \rangle - \langle S_{A_\xi v} w, \eta \rangle \\ &= \langle ([S_v, S_w] - S_v S_w + S_w S_v) \xi, \eta \rangle = 0 \end{aligned}$$

It remains to show  $(\text{ad}_x)^3 = -\text{ad}_x$ . Note first that  $T = [\mathfrak{k}, x]$  and hence  $\xi \in N \iff 0 = \langle [\mathfrak{k}, x], \xi \rangle = \langle \mathfrak{k}, [x, \xi] \rangle \iff [x, \xi] = 0$ . Thus  $\ker \text{ad}_x \cap V = N$  while  $\ker \text{ad}_x \cap \mathfrak{k} = \mathfrak{k}_+$ . Their complements  $T$  and  $\mathfrak{k}_-$  are mapped isomorphically onto each other by  $\text{ad}_x$ , more precisely, for all  $v \in T$  we have

$$\text{ad}_x S_v = -S_v x = A_x v = -v, \quad \text{ad}_x v \stackrel{(8)}{=} -S_{A_x v} = S_v.$$

Thus  $(\text{ad}_x)^2 = -I$  on  $\mathfrak{k}_- + T$  and  $\text{ad}_x = 0$  on  $\mathfrak{k}_+ + N$ . It follows that  $\text{ad}_x$  has eigenvalues  $\pm i$  and 0 which is equivalent to  $(\text{ad}_x)^3 = -\text{ad}_x$ . We have proved:

**Theorem 4.** *Extrinsic symmetric spaces  $M = K/K_+$  lie in an orthogonal Lie triple  $V = \mathfrak{p}$  which belongs to as symmetric space  $P = G/K$ . They are orbits  $\text{Ad}_K x$  of the connected automorphism group  $K$  of the Lie triple  $\mathfrak{p}$ , and the Lie triple structure can be chosen such that*

$$(\text{ad}_x)^3 = -\text{ad}_x. \quad (9)$$

<sup>14</sup>We also use that the mapping  $v \mapsto S_v: T \rightarrow \mathfrak{k}_-$  is  $K_+$ -equivariant,  $S_{kv} = k S_v k^{-1}$ , and consequently  $S_{Av} = [A, S_v]$  for every  $A \in \mathfrak{k}_+$ .

## 5. How to classify ESS.

The classification uses the condition (9). Lie triples  $\mathfrak{p}$  containing elements  $x$  with  $\text{ad}_x^3 = -\text{ad}_x$  have been investigated and classified already 1964 by Kobayashi and Nagano [18]. This is not difficult if we use the *root system* of  $\mathfrak{p}$ . Let  $P = G/K$  be a symmetric space with Lie triple  $\mathfrak{p}$ . Recall: for any maximal abelian subalgebra  $\mathfrak{a} \subset \mathfrak{p}$  (that is  $[\mathfrak{a}, \mathfrak{a}] = 0$ ), the skew adjoint linear maps  $\text{ad}_a : \mathfrak{g} \rightarrow \mathfrak{g}$ ,  $a \in \mathfrak{a}$  commute and thus have simultaneous eigenvalues  $i\alpha(a)$  (where  $i = \sqrt{-1}$ ) for some real linear form  $\alpha$  on  $\mathfrak{a}$ ; these linear forms are called *roots* of  $\mathfrak{p}$ , the corresponding simultaneous eigenspaces  $\mathfrak{g}_\alpha \subset \mathfrak{g} \otimes \mathbb{C}$  are the *root spaces*. Since  $\text{ad}_a$  is a real endomorphism, its eigenvalues come in conjugate pairs, thus roots come in pairs  $\pm\alpha$ . There is a subset  $\alpha_1, \dots, \alpha_r$  (called *simple roots* such that for any root  $\alpha$  there are nonnegative integers  $n_1, \dots, n_r$  with  $\alpha = \sum_i n_i \alpha_i$  ("positive roots") or  $-\alpha = \sum_i n_i \alpha_i$  ("negative roots"). There is one root  $\delta$ , called *highest root*, all of whose coefficients  $n_i(\delta)$  are maximal, that is  $n_i(\delta) \geq n_i(\alpha)$  for any root  $\alpha$  and all  $i \in \{1, \dots, r\}$ .

Let  $x \in \mathfrak{p}$  with (9). Hence  $i, 0, -i$  are the only eigenvalues of  $\text{ad}_x$ . We may assume  $x \in \mathfrak{a}$  and that  $\alpha_i(x) \geq 0$  for  $i = 1, \dots, r$ . On  $\mathfrak{g}_\alpha$  we have  $\text{ad}_x = i\alpha(x)$ . Thus  $\alpha(x) \in \{0, \pm 1\}$ . In particular this holds for the highest root, hence  $\delta(x) = \sum_i n_i(\delta)\alpha_i(x) = 1$ . Since all  $n_i(\delta) \geq 1$ , the element  $x$  must be a *dual root*  $x = \xi_j$  for some  $j \in \{1, \dots, r\}$  with  $n_j(\delta) = 1$ , that is  $\alpha_j(x) = 1$  and  $\alpha_i(x) = 0$  for all  $i \neq j$ . Below we display the Dynkin diagrams of the simple root systems with the numbers  $n_j(\delta)$  attached to  $\alpha_j$  [24, p. 65]. The extrinsic symmetric elements  $x$  are dual to simple roots with weight 1.

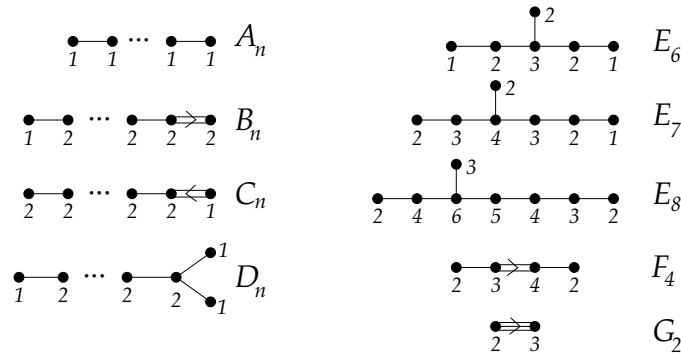

**Theorem 5.** *The following table lists  $M$ ,  $G$ ,  $K$ ,  $K_+$  where  $K/K_+ \cong M \subset \mathfrak{p}$  is indecomposable extrinsic symmetric and  $\mathfrak{p}$  is the Lie triple of the symmetric space  $P = G/K$ , see [2, p. 311], [11].*

$M$	$G$	$K$	$K_+$
$SO_n$	$SO_{2n}/(\pm)$	$(SO_n \times SO_n)/\pm$	$\Delta SO_n/\pm$
$U_n$	$U_{2n}/\mathbb{S}^1$	$(U_n \times U_n)/\Delta \mathbb{S}^1$	$\Delta U_n/\mathbb{S}^1$
$Sp_n$	$Sp_{2n}$	$(Sp_n \times Sp_n)/\pm$	$\Delta Sp_n$
$G_p(\mathbb{R}^n)$	$SU_n$	$SO_n/\pm$	$S(O_p \times O_{n-p})/\pm$
$G_p(\mathbb{H}^n)$	$SU_{2n}$	$Sp_n/\pm$	$(Sp_p \times Sp_{n-p})/\pm$
$U_n/O_n$	$Sp_n$	$U_n/\pm$	$O_n/\pm$
$U_{2n}/Sp_n$	$SO_{4n}$	$U_{2n}/\pm$	$Sp_n/\pm$
$(\mathbb{S}^p \times \mathbb{S}^q)/\pm$	$SO_{p+q+2}$	$(SO_{p+1} \times SO_{q+1})/(\pm)$	$S(O_p \times O_q)/(\pm)$
$(SU_8/Sp_4)/\mathbb{Z}_2$	$E_7$	$SU_8/\mathbb{Z}_4$	$Sp_4/\pm$
$(\mathbb{S}^1 \cdot E_6)/F_4$	$E_7$	$(\mathbb{S}^1 \times E_6)/\Delta \mathbb{Z}_3$	$F_4$
$G_2(\mathbb{H}^4)/\mathbb{Z}_2$	$E_6$	$Sp_4/\pm$	$Sp_2 \times Sp_2$
$\mathbb{O}\mathbb{P}^2$	$E_6$	$F_4$	$Spin_9$

**Example.** Consider  $M = SO_n \subset \mathbb{R}^{n \times n}$ . Though  $\mathbb{R}^{n \times n}$  is a Lie algebra, this is not the Lie triple system we are using. Instead, we embed  $\mathbb{R}^{n \times n}$  into  $\mathbb{R}^{2n \times 2n}$  by  $X \mapsto \begin{pmatrix} X & -X^T \\ & \end{pmatrix}$ . The image is the Lie triple  $\mathfrak{p}$  corresponding to  $G_n(\mathbb{R}^{2n})$  with the isotropy representation of  $K = SO_n \times SO_n$ . Then  $M = Kx$  with  $x = \begin{pmatrix} I & -I \\ & \end{pmatrix}$ , hence  $M = \{ \begin{pmatrix} g & -g^T \\ & \end{pmatrix} : g \in SO_n \}$ . Note that  $x$  commutes with  $\begin{pmatrix} A & -A \\ & \end{pmatrix}$  and anti-commutes with  $\begin{pmatrix} S & S \\ & \end{pmatrix}$  and  $\begin{pmatrix} S & -S \\ & \end{pmatrix}$  where  $A^T = -A$  and  $S^T = S$ . Thus  $\text{ad}_x = 0$  on  $T_x M$  and  $(\text{ad}_x)^2 = -I$  on  $N_x M$  which shows  $\text{ad}_x^3 = -\text{ad}_x$ .

## 6. ESS are real forms of hermitian symmetric spaces.

In section 3 we have seen that any hermitian symmetric space  $\hat{M}$  is extrinsic symmetric. Then the Lie triple  $\mathfrak{p}$  is a Lie algebra  $\mathfrak{g}$  with its adjoint representation  $\text{Ad}_G$ , and  $\hat{M} = \text{Ad}_G x$  for some  $x \in \mathfrak{g}$  with  $(\text{ad}_x)^3 = -\text{ad}_x$ . Thus  $(\text{ad}_x)^2 = -I$  on  $\mathfrak{m} := \text{im ad}_x = [\mathfrak{g}, x] = \hat{T}$  (tangent space of the orbit  $\hat{M}$ ) and  $\text{ad}_x = 0$  on  $\mathfrak{h} = \ker \text{ad}_x = \hat{N}$  which is the Lie algebra of the isotropy group  $H = \{g \in G : gx = x\}$ . Hence  $J_x := \text{ad}_x$  is a complex structure on  $\hat{T}$  and 0 on  $\hat{N}$ , and  $\tau = e^{\pi \text{ad}_x} = \text{Ad}_{\exp(\pi \text{ad}_x)}$  is the extrinsic symmetry.

What about the other extrinsic symmetric spaces? In the general case we have a symmetric space  $P = G/K$  with Cartan decomposition  $\mathfrak{g} = \mathfrak{k} \oplus \mathfrak{p}$  and  $M = \text{Ad}_K x \subset \mathfrak{p}$  for some  $x \in \mathfrak{p} \subset \mathfrak{g}$  with  $(\text{ad}_x)^3 = -\text{ad}_x$ . Obviously, the  $K$ -orbit  $M$  is contained in the  $G$ -orbit  $\hat{M} = \text{Ad}_G x$  which is hermitian symmetric. But even more is true:  $M \subset \hat{M}$  is a *reflective* submanifold, a fixed point component of an isometric involution. The reflection is  $\rho = -\sigma$  where  $\sigma \in \text{Aut}(\mathfrak{g})$  is the Cartan involution of the symmetric pair  $(\mathfrak{g}, \mathfrak{k})$ , that is  $\rho = I$  on  $\mathfrak{p}$  and  $\rho = -I$  on  $\mathfrak{k}$ . In fact,  $\rho$  fixes  $x \in \mathfrak{p}$  and leaves  $\hat{M}$  invariant since  $\tau(\text{Ad}_g x) = -\sigma(\text{Ad}_g x) = -\text{Ad}_{\sigma g} \sigma x = \text{Ad}_{\sigma g} x$ . Thus  $\hat{T} = T_x \hat{M}$  splits into the  $\rho$ -eigenspaces,  $\hat{T} = \hat{T} \cap \mathfrak{p} \oplus \hat{T} \cap \mathfrak{k}$ , and  $\hat{T} \cap \mathfrak{p} = T$ . Hence the fixed point component of  $\rho$  through  $x$  is tangent to  $T = T_x M$  which shows that  $M$  is a fixed point component of  $\rho$ .

**Lemma.**  $\rho|_{\hat{M}}$  is anti-holomorphic.

*Proof.* We have  $J_{gx} = \text{ad}_{gx}$  for all  $g \in G$  where  $gx$  means  $\text{Ad}_g x$ . Thus for any  $v \in \hat{T} = T_x \hat{M}$

$$\begin{aligned} \rho(J_{gx}gv) &= \rho([gx, gv]), \\ J_{\rho gx}(\rho gv) &= [\rho gx, \rho gv] = \sigma([gx, gv]) = -\rho([gx, gv]), \end{aligned}$$

hence for all  $y = gx \in \hat{M}$  and  $w = gv \in T_y \hat{M}$  we have  $\rho(J_y w) = -J_{\rho y} \rho w$ . □

In particular,  $\rho|_{\hat{T}}$  is complex antilinear with respect to the complex structure  $J = \text{ad}_x$  on  $\hat{T}$ . In particular,  $\dim M = \frac{1}{2} \dim \hat{M}$  since  $J$  interchanges the  $\pm 1$ -eigenspaces of  $\rho$ . Such submanifold  $M \subset \hat{M}$  is a *real form* of the hermitian symmetric space  $\hat{M}$ , that is a reflective submanifold with respect to an antiholomorphic involution.

Vice versa, real forms  $M$  of hermitian symmetric spaces  $\hat{M}$  are *reflective*, fixed component of an involution on  $\hat{M}$ . Reflective submanifolds of extrinsic symmetric spaces are extrinsic symmetric, see the subsequent Lemma. Thus we have seen:

**Theorem 6.** (Takeuchi [28]) *Extrinsic symmetric spaces are precisely the real forms of hermitian symmetric spaces.*



More precisely, the hermitian symmetric spaces have the following real forms [16].

Hermit. sym. space	restrictions	real forms
$G_2^+(\mathbb{R}^{n+2})$	$n = p + q$	$(\mathbb{S}^p \times \mathbb{S}^q)/\pm$
$G_p(\mathbb{C}^n)$	$n = 2p$	$U_p$
	none	$G_p(\mathbb{R}^n)$
	$p, n$ even	$G_{p/2}(\mathbb{H}^{n/2})$
$SO_{2n}/U_n$	none	$SO_n$
	$n$ even	$U_n/Sp_{n/2}$
$Sp_n/U_n$	$n$ even	$Sp_{n/2}$
	none	$U_n/O_n$
$E_7/\mathbb{S}^1 \cdot E_6$		$(SU_8/Sp_4)/\mathbb{Z}_2$
		$\mathbb{S}^1 \cdot E_6/F_4$
$E_6/\mathbb{S}^1 \cdot Spin_{10}$		$G_2(\mathbb{H}^4)/\mathbb{Z}_2$
		$\mathbb{O}\mathbb{P}^2$

**Example 1.**  $(\mathbb{S}^p \times \mathbb{S}^q)/\pm \subset G_2^+(\mathbb{R}^{n+2})$ . The embedding assigns to each pair  $(x, y) \in \mathbb{S}^p \times \mathbb{S}^q$  the oriented plane with basis  $\pm(x, y)$ . This corresponds to  $[x+iy] \in \mathbb{C}\mathbb{P}^{n+1}$  when  $G_2^+(\mathbb{R}^{n+2})$  is considered as the quadric  $Q = \{[w] \in \mathbb{C}\mathbb{P}^{n+1} : \sum w_i^2 = 0\}$ . Apparently,  $(\mathbb{S}^p \times \mathbb{S}^q)/\pm$  is the set of those oriented planes on which the reflection  $S = \begin{pmatrix} I_p & \\ & -I_q \end{pmatrix}$  has the same effect as the involution  $\kappa$  mapping any plane  $E = \text{Span}(x, y)$  onto itself while changing the orientation from  $(x, y)$  into  $(x, -y)$ . This map  $\kappa$  is just complex conjugation  $[v] \mapsto [\bar{v}]$  on  $Q \subset \mathbb{C}\mathbb{P}^{n+1}$ . In other words,  $(\mathbb{S}^p \times \mathbb{S}^q)/\pm$  is the fixed set of the involution  $\tau : E \mapsto \kappa(SE)$  which is an anti-holomorphic involution on  $G_2^+(\mathbb{R}^{n+2})$ .

**Example 2.**  $U_p \subset G_p(\mathbb{C}^{2p})$ . The embedding of  $U_p$  into the Grassmannian  $G_p(\mathbb{C}^{2p})$  assigns to each  $A \in U_p$  its graph  $E_A = \{(x, y) \in \mathbb{C}^p \oplus \mathbb{C}^p : y = Ax\}$ . In other words,  $E \in U_p$  for some  $E \in G_p(\mathbb{C}^{2p})$  iff for any  $x \in \mathbb{C}^p$  there is a (unique)  $y \in \mathbb{C}^p$  with  $(x, y) \in E$ , and further  $\langle x, u \rangle = \langle y, v \rangle$  for all  $\begin{pmatrix} x \\ y \end{pmatrix}, \begin{pmatrix} u \\ v \end{pmatrix} \in E$ . Equivalently, the matrix  $S = \begin{pmatrix} I_p & \\ & -I_p \end{pmatrix}$  turns  $E$  into  $E^\perp$  since  $\langle S \begin{pmatrix} x \\ y \end{pmatrix}, \begin{pmatrix} u \\ v \end{pmatrix} \rangle = \langle x, u \rangle - \langle y, v \rangle = 0$ . Thus  $U_p \subset G_p(\mathbb{C}^{2p})$  is the fixed space under the involution  $\tau : E \mapsto -SE$ . Recall that  $G_p(\mathbb{C}^{2p})$  is embedded into the Lie algebra  $\mathfrak{u}_{2p}$  by  $E \mapsto ir_E$  where  $r_E$  is the reflection along  $E$  (with  $(\pm 1)$ -eigenspaces  $E$  and  $E^\perp$ ). Then  $r_{E^\perp} = -r_E$ . Thus in this model,  $\tau$  is the map  $r_E \mapsto -r_{SE} = -Sr_ES^{-1}$  which is the conjugation with  $iS \in U_{2p}$ . Since  $ir_E$  defines the complex structure on  $G_p(\mathbb{C}^{2p})$ , the involution  $\tau$  is antiholomorphic since it maps  $r_E$  to  $-r_{SE}$ .

**Lemma.** *Every reflective submanifold  $M \subset \hat{M}$  is totally geodesic. If  $\hat{M}$  is extrinsic symmetric then so is  $M$ .*

*Proof.* A Reflective submanifold  $M \subset \hat{M}$  (a fixed component of some involution  $\rho$  on  $\hat{M}$ ) is totally geodesic: every geodesic in  $M$  is also a geodesic in  $\hat{M}$ . This follows from the uniqueness of small geodesic segments  $\hat{\gamma}$  in the ambient space  $\hat{M}$  with end points in  $M$ , see figure.

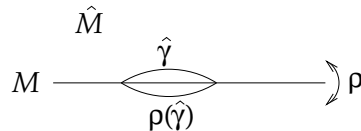

Now let  $\hat{M} \subset \hat{V}$  be extrinsic symmetric. As we will see in section 9, any isometry  $\rho$  of  $\hat{M}$  extends to an isometry  $\tilde{\rho}$  of the ambient vector space  $V$  (the argument is easy when  $\hat{M}$  is Kähler symmetric). Let  $F \subset V$  be the fixed space of  $\tilde{\rho}$ . Then  $M = \hat{M} \cap F$ . We show that  $M \subset F$  is extrinsic symmetric. For any  $x \in M$  let  $r_x$  be the extrinsic symmetry of  $\hat{M}$  at  $x$ . Since  $\tilde{\rho}$  is an extrinsic isometry of  $\hat{M}$ , it conjugates the extrinsic symmetries:  $\tilde{\rho}r_x\tilde{\rho}^{-1} = r_{\tilde{\rho}x}$ . But  $\tilde{\rho}x = x$  since  $x \in F$ . Thus  $r_x$  commutes with  $\tilde{\rho}$  and thus keeps the eigenspace  $F$  of  $\tilde{\rho}$  invariant, defining an extrinsic reflection for  $M \subset F$ .

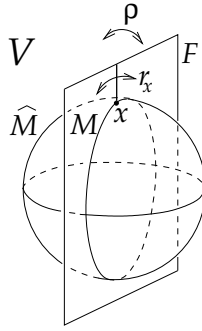

## 7. ESS are midpoint components between center elements.

Since  $V = \mathfrak{p}$  is a Lie triple, it is the tangent space  $T_oP$  of a symmetric space  $P = G/K$  which we may choose to be compact and simply connected. For any  $x \in M \subset V$  we consider the geodesic  $\gamma_x$  in  $P$  which starts from  $o = eK \in P$  with  $\gamma'_x(0) = x$ . Thus we define an  $m$ -parameter geodesic variation ( $m = \dim M$ ) whose variational vector fields (Jacobi fields) along  $\gamma_x$  (when expressed in a parallel orthonormal basis along  $\gamma_x$ ) solve the ODE  $J'' + R_x J = 0$  with  $R_x v := R(v, x)x$ . For any  $v \in T_x M$  we have  $R(v, x)x = -[[v, x], x] = -(\text{ad}_x)^2 v = v$  since from  $(\text{ad}_x)^3 = -\text{ad}_x$  we obtain  $(\text{ad}_x)^2 = -I$  on  $T_x M$ . Using the initial condition  $J(0) = 0$  (all geodesics of the variation start at  $o$ ), we obtain  $J(t) = (\sin t)v$ . Hence  $M_t := \exp_o(tM)$  is equivariantly diffeomorphic to  $M$  for all  $t \in (0, \pi)$ , and  $\exp_o(\pi M)$  is a single point  $p$  which is thus fixed by the action of  $K$ . We consider the midpoint set  $M' := M_{\pi/2}$ . This is totally geodesic [20, 25] as we shall see below.

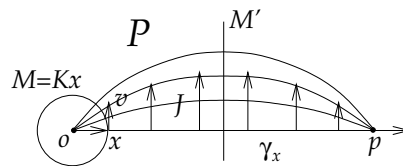

The set of points  $p \in P$  which are fixed by  $K$  is called the *center*<sup>15</sup> of  $(P, o)$ . This is the orbit of  $o$  under the normalizer group  $N = \{g \in G : gKg^{-1} = K\}$ . Since the symmetry  $s_o$  at  $o$  commutes with any  $k \in K$ , conjugation with  $s_o$  preserves  $N$ .<sup>16</sup> Thus  $s_o$  descends from  $P = G/K$  to  $\check{P} := G/N$  making  $\check{P}$  a symmetric space covered by  $P$ , the so called *bottom space* for  $P$ . Let  $\pi : P \rightarrow \check{P}$  be the covering map. It maps the center of  $(P, o)$  to the single point  $\check{o} = \pi(o)$ , and  $\pi \circ \gamma_x : [0, \pi] \rightarrow \check{P}$  is a closed geodesic. The submanifold  $\check{M} := \pi(M) \subset \check{P}$  consists of the midpoints of geodesic segments starting and ending at  $\check{o}$ ; their midpoints are obviously fixed by the symmetry  $s_{\check{o}}$ . Fixed point components

<sup>15</sup> If  $P$  is a compact Lie group  $G$  with unit  $e$ , the center of  $(G, e)$  is the center in the sense of group theory, the set of  $c \in G$  commuting with any  $g \in G$ . In fact, the isotropy group  $K$  at  $e$  is  $G$  itself, acting on  $G$  by conjugation, and an element  $c \in G$  is fixed under conjugation with  $g \in G$  iff  $gc = cg$ .

<sup>16</sup> For all  $n \in N$  and  $k \in K$  we have  $s_o n s_o k = s_o n k s_o = s_o k' n s_o = k' s_o n s_o$  where  $k' = nkn^{-1} \in K$ , hence  $s_o n s_o \in N$ .

of the symmetry at  $\check{o}$  are called *poles* of  $\check{o}$  if they are isolated points, and *polars* of  $\check{o}$  if they have positive dimension. A polar is reflective, hence totally geodesic. Thus the preimage  $M$  under the local isometry  $\pi$  is also totally geodesic.<sup>17</sup>

The construction can be reversed: midpoints between center elements belong to extrinsic symmetric spaces. In fact, let  $P = G/K$  be a symmetric space with base point  $o$  and let  $p$  be a point in the center of  $(P, o)$ . Consider the set of midpoints  $m = \gamma(1)$  for all shortest geodesics  $\gamma : [0, 2] \rightarrow P$  from  $o$  to  $p$ . Each of its connected components  $M$  is a  $K$ -orbit  $Kv$  with  $\gamma_v(1) = m$  for some  $m \in M$ . Note that  $\exp_o : Kv \rightarrow M$  is a diffeomorphism since a shortest geodesic from  $o$  to  $p$  is uniquely determined by its mid point. Under the projection  $\pi : P \rightarrow \check{P}$  we have  $\check{o} = \check{p}$  and  $\pi(M) = \check{M}$  is a fixed component for the symmetry  $s_{\check{o}}$ , hence a *polar* for  $\check{o}$ . Then  $\exp_{\check{o}} : Kv \rightarrow \check{M}$  is a local diffeomorphism. This implies that  $Kv \subset T_oM$  is extrinsic symmetric, see the following lemma, applied to  $\check{P}$  in place of  $P$ .

**Lemma.** *Let  $P = G/K$  be a symmetric space with  $G, K$  connected and  $o = eK \in P$  its base point. Let  $M = K \exp_o v \subset P$  be a polar for  $o$  such that  $\exp_o : Kv \rightarrow M$  is a local diffeomorphism. Then  $Kv \subset T_oP$  is extrinsic symmetric.*

*Proof.* The polar  $M$  is a fixed component of the symmetry  $s_o$ . Through any  $m = \exp_o v \in M$  there is a perpendicular reflective submanifold  $M^\perp \subset P$  called *meridian*: the fixed set component of  $s_m s_o$  through  $m$ . The geodesic  $\gamma_v(t) = \exp_o(tv)$  is closed since it is reversed by  $s_o$  which fixes  $m = \gamma_v(1)$ . It is also reversed by  $s_m$ , hence it is preserved by  $s_m s_o$ , thus it belongs to  $M^\perp$ , and in particular,  $d(s_m s_o)_o$  fixes  $v$ .

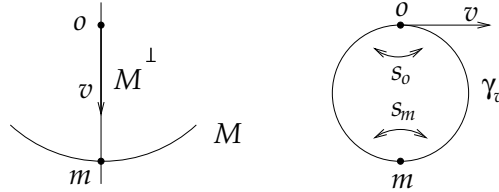

Further,  $\exp := \exp_o$  is equivariant with respect to isometries of  $P$  fixing  $o$ , that is  $f \circ \exp = \exp \circ df_o$  for each such isometry  $f$ . Differentiating at some  $v \in T_oP$  we obtain

$$df_{\exp v} \circ d \exp_v = d \exp_{df_o v} \circ df_o. \quad (10)$$

We apply this equality to  $f := s_m s_o$  fixing  $m = \exp v$  and restrict it to  $T_v(Kv) \subset T_oP$ . Since  $df_o v = v$ , we have

$$df_m \circ d \exp_v = d \exp_v \circ df_o$$

On the left hand side we have  $df_m = -I$  on  $T_mM = d \exp_v(T_v(Kv))$ . Since  $d \exp_v$  is injective on  $T_v(Kv)$ , we obtain also on the right hand side  $df_o = -I$  on  $T_v(Kv)$ . Thus the  $(\pm 1)$ -eigenspaces of  $df_o$  contain in  $T_o(M^\perp)$  and  $T_v(Kv)$ , respectively, and since the dimensions of these subspaces of  $T_oP$  are complementary, these are precisely the eigenspaces. Hence  $Kv$  is extrinsic symmetric with extrinsic symmetry  $f$  at  $m = \exp v$ .  $\square$

We have proved:

<sup>17</sup>In fact, also  $M \subset P$  is reflective, see the remark below.

**Theorem 7.** *Extrinsic symmetric spaces  $M$  lie in a Lie triple  $V = \mathfrak{p} = T_oP$ , and  $M$  can be embedded into  $P$  via  $\exp_o$  as midpoint components of shortest geodesic from  $o$  to center of  $(P, o)$ . In fact this component is unique [20], so there is a one-to-one correspondence between extrinsic symmetric spaces and center elements.*

A particular case is when  $p$  is a center element of order 2, that is  $\gamma(2\pi) = o$  where  $\gamma|_{[0,\pi]}$  is a shortest segment from  $o$  to  $p$  as above. Then  $p$  is an isolated fixed point of  $s_o$ , a pole, and  $M'$  is called a *centriole*, see [6]. The corresponding extrinsic symmetric spaces  $M \subset \mathfrak{p}$  are precisely those with  $-M = M$ , sometimes called *self-dual* [5]. E.g. among the Grassmannians only those of half-dimensional subspaces are self-dual. Chains of centrioles play a crucial role in the proof of the *Bott periodicity theorem*, see [21]. In fact, the points in centrioles are in one-to-one correspondence to shortest geodesics between poles, and when non-minimal geodesics have high index, the set of minimal geodesics may replace the full path space for low-dimensional homotopy.

**Remark.** A midpoint component  $M$  between center elements is not a polar; it becomes a polar only after applying the projection  $\pi : P \rightarrow \check{P}$ . But we can still show that  $M$  itself is reflective as follows. This isometry  $\check{r} = s_{\check{m}}s_{\check{o}}$  is covered by  $\delta s_o s_m$  for any *deck transformation*  $\delta$  of  $\pi : P \rightarrow \check{P}$ , that is  $\delta \in G$  with  $\pi \circ \delta = \pi$ . We will choose a particular  $\delta$ . The geodesic  $\pi \circ \gamma$  is closed, and since  $\pi$  is a finite covering, the extension of  $\gamma$  is also closed (with  $k$ -fold period). Let  $\delta \in G$  be the deck transformation of order  $k$  sending  $o$  to  $p$  by translating  $\gamma$ . We claim that  $r := \delta s_o s_m$  fixes  $\gamma : \mathbb{S}^1 \rightarrow P$  pointwise. In fact, all three isometries  $\delta, s_o, s_m$  keep  $\gamma$  invariant,<sup>18</sup> but  $s_o$  and  $s_m$  act by reflections while  $\delta$  acts by rotation on  $\mathbb{S}^1$ , shifting the parameter. The “rotation angle” (parameter shift) is twice the distance between  $o$  and  $m$ , hence  $\delta = s_m s_o$  along  $\gamma$  which proves our claim.

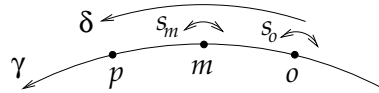

In particular,  $r$  keeps  $o$  fixed, hence  $r \in K$ . It also fixes  $m$ , and since it descends to the extrinsic symmetry  $\check{r}$  of  $M \subset \check{P}$  at  $\check{m}$ , the differential of  $r$  at  $m \in M$  looks as that of  $\check{r}$  at  $\check{m}$ : it is  $-I$  on  $T_m M$  and  $+I$  on  $N_m M$  (= the normal space of  $M \subset P$ ). Thus  $M$  is a fixed component of  $s_m \circ r$ .

## 8. Maximal tori of ESS are products of planar circles.

Which symmetric spaces allow extrinsic symmetric embeddings? Ottmar Loos [19] has given the following characterization: precisely those whose maximal torus is isometric to a product of circles. In fact, a little more is true [10]: maximal tori of extrinsic symmetric spaces are again extrinsic symmetric and hence an extrinsic product of planar circles, by the following lemma:

**Lemma.** [14, Thm. 3] *Let  $F \subset V$  be extrinsic symmetric and full and a flat  $r$ -dimensional torus with respect to the induced metric. Then  $F$  splits extrinsically as  $F = C_1 \times \dots \times C_r$  where  $C_i \subset V_i \cong \mathbb{R}^2$  are planar circles and  $V$  is the orthogonal direct sum of the  $V_i, i = 1, \dots, r$ .*

*Proof.* Since the torus  $F$  is flat, there exists a basis of parallel tangent vector fields  $X_a, a = 1, \dots, r$ , and thus  $\alpha_{ab} = \alpha(X_a, X_b)$  are parallel normal fields spanning the normal

<sup>18</sup> Clearly  $s_o, s_m$  preserve  $\gamma$ . Also the deck transformation  $\delta$  preserves  $\gamma$  since  $\delta$  maps the tangent vector of  $\gamma$  at  $o$  to that at  $p$ , this is because  $\gamma$  covers  $\check{\gamma}$ , and hence the tangent vectors of  $\gamma$  at  $o$  and  $p$  are both projected to the tangent vector of  $\check{\gamma}$  at  $\check{o} = \check{p}$ .

bundle  $NF$ . The shape operators  $A_{\alpha_{ab}}$  are parallel too, and they commute because of the Ricci equation  $[A_\xi, A_\eta] = -R_{\xi, \eta}^N$  which vanishes when  $\xi$  is parallel. Thus the  $A_{\alpha_{ab}}$  have a parallel common eigenspace decomposition  $TF = E_1 \oplus \dots \oplus E_r$ , and in particular  $\alpha(E_i, E_j) = 0$  for  $i \neq j$ . We claim that there is a corresponding extrinsic decomposition  $F = F_1 \times \dots \times F_r$  with  $F_i \subset V_i$  and  $V = V_1 \oplus \dots \oplus V_r$ . In fact,  $\alpha(E_i, E_i) \perp \alpha(E_j, E_j)$  for any  $i \neq j$  since  $\langle \alpha(E_i, E_i), \alpha(E_j, E_j) \rangle = |\alpha(E_i, E_j)|^2 = 0$  by Gauss equations (using that  $F$  is flat). Hence  $\langle \partial_v \alpha(E_i, E_i), w \rangle = -\langle \alpha(E_i, E_i), \alpha(v, w) \rangle = 0$  whenever  $v$  or  $w$  are perpendicular to  $E_i$ . In particular, the linear subspace  $V_i = E_i \oplus \alpha(E_i, E_i)$  satisfies  $\partial V_i \subset V_i$  and hence it is constant, that is independent of  $x \in F$ .

It remains to show that  $F_i \subset V_i$  is a circle in a plane. In fact, by definition of  $E_i$  we have  $A_{\alpha_{ab}} = \lambda_{ab}^i I$  on  $E_i$  for some real constant  $\lambda_{ab}^i$ . Hence for  $v, w \in E_i$  we have  $\langle \alpha(v, w), \alpha_{ab} \rangle = \langle A_{\alpha_{ab}} v, w \rangle = \lambda_{ab}^i \langle v, w \rangle$ . Thus  $\alpha(v, w) / \langle v, w \rangle$  does not depend on  $v, w$  which shows that  $\alpha(v, w) = \langle v, w \rangle \eta_i$  for some  $\eta_i \in \alpha(E_i, E_i) \subset N$  and all  $v, w \in E_i$ . In particular,  $F_i$  has codimension one in  $V_i$ . Thus  $F_i$  is a sphere of radius  $1/|\eta_i|$ : Note that  $A_{\eta_i} = -|\eta_i|^2 I$  and hence for the position vector  $x$  we have  $\partial_v(x + tA_{\eta_i}) = v - t|\eta_i|^2 v = 0$  for  $t = 1/|\eta_i|^2$ . Thus the point  $c = x + \eta_i/|\eta_i|^2$  is constant along  $F_i$ : this is the center of the sphere. Since  $F_i$  is flat, it must be one-dimensional, a circle.  $\square$

Unfortunately, we cannot show directly that the maximal torus  $F \subset M$  (the “flat”) is an extrinsic symmetric subspace of  $M$ . But we find an extrinsic symmetric subspace  $M' \subset M$  with yet the same maximal torus  $F$  such that  $M'$  is intrinsically a metric product of a torus  $F'$  with some round spheres  $S_i$ , and for such  $M'$  it is easy to show that the maximal torus is itself extrinsic symmetric.

The main technical tool is the observation that reflective submanifolds of extrinsic symmetric spaces are extrinsic symmetric, see Lemma in section 6. This can be used first to show that the maximal torus of  $M'$  is a product of circles, using the reflections along a point or a great circle in every single sphere factor.<sup>19</sup> But the same argument proves also the reduction from  $M$  to  $M'$ . We claim that the so called *meridians* are extrinsic reflective submanifolds of  $M$  containing a maximal torus of  $M$ .

Recall that reflective submanifolds in a symmetric space  $M$  appear in orthogonal pairs: If  $P_1 \subset M$  is reflective, a fixed component of a reflection  $\tau$ , there is an orthogonal reflective submanifold  $M_1$  through any  $p \in P_1$  which is a fixed component of  $s_p \tau$ . In particular, if  $P_1$  is a *polar*, that is a positive-dimensional fixed component of a symmetry  $\tau = s_x$  of  $M$ , then  $M_1$  is called a *meridian*, cf. [6]. Consider a shortest geodesic  $\gamma$  from  $x$  to  $P_1$  with end point  $p \in P_1$ . Then  $\gamma$  meets  $P_1$  perpendicularly at  $p$ , hence it belongs to  $M_1$ . The geodesic  $\gamma$  extends beyond  $p$  to a geodesic segment starting and ending at  $x$  with midpoint  $p$ . Let  $F$  be a maximal torus of  $M$  with  $\gamma \subset F$ . Since  $s_x$  keeps  $F$  invariant,  $p$  is a pole or an element of a polar for  $x$  also in  $F$ . But a flat torus cannot have polars,<sup>20</sup> hence  $p$  is an isolated fixed point of  $s_x$  in  $F$ , a *pole*. In other words,  $s_p = s_x$  along  $F$ . Thus  $F$  belongs to the fixed component of  $s_p s_x$  through

<sup>19</sup> The fixed set of the reflection along a great circle  $C_i$  in one of the sphere factors  $S_i$  of  $M'$  is the product of  $C_i$  with the remaining factors. Repeating this process for the fixed set we end up with the maximal torus  $F = C_1 \times \dots \times C_r \times F_o$  of  $M'$ . But why is this reflection extrinsic? This is obvious only if  $n_i = \dim S_i$  is odd since the reflection along a plane in  $\mathbb{R}^{n_i+1}$  has positive determinant (and thus lies in the transvection group) iff  $n_i$  is odd. But if  $n_i$  is even, we can use the point reflection in  $S_i$  (which is now a transvection); its fixed component is the product omitting the factor  $S_i$ . However, we will see in section 9 that *all* isometries are extrinsic.

<sup>20</sup> The shortest geodesics from  $x$  to a polar  $P_x$  meet the totally geodesic subspace  $P_x$  perpendicularly, hence the corresponding Jacobi fields vanishing at  $x$  have zero derivative at  $P_x$  which is impossible in a flat space.

$p$ : this is the meridian  $M_1$ . Repeating the process by taking meridians of meridians  $M \supset M_1 \subset M_2 \supset \dots$ , we end up with an extrinsic symmetric space  $M_k = M'$  without a polar.

We claim first that every totally geodesic semisimple<sup>21</sup> subspace of  $M'$  is simply connected. Otherwise, such subspace  $M'' \subset M'$  had a nontrivial covering  $\pi : \widetilde{M}'' \rightarrow M''$ . Let  $\tilde{\gamma}$  be a shortest geodesic connecting two preimages  $\tilde{x}_1, \tilde{x}_2$  of  $x \in M''$  and  $\tilde{p}$  its midpoint. Then  $p = \pi(\tilde{p})$  is the midpoint of the geodesic  $\gamma = \pi \circ \tilde{\gamma}$  in  $M''$  starting and ending at  $x$ . Thus  $p$  is a pole or an element of a polar of  $x$ . But if it were a pole, all Killing fields (infinitesimal isometries) vanishing at  $x$  would also vanish at  $p$  and  $p$  were a conjugate point for  $x$ . This is excluded since the lift  $\tilde{\gamma}$  is shortest beyond  $\tilde{p}$ . Thus  $p$  lies in a polar to  $x$  in  $M'' \subset M'$  which was excluded. This proves our claim.

Now we know that any semisimple totally geodesic subspace  $M'' \subset M'$  is simply connected. Then in a maximal torus  $F''$  of  $M''$ , the unit lattice  $\Gamma = \{v \in T_x F'' : \exp_x v = x\}$  is spanned by the *inverse roots*  $\check{\delta} = 2\delta^*/\langle \delta, \delta \rangle$  where  $\delta$  runs through the root system of  $M''$  for the maximal abelian subalgebra  $\mathfrak{a} = T_x F''$  (see section 5) and where  $\delta^* \in \mathfrak{a}$  is the root vector,  $\langle \delta^*, v \rangle = \delta(v)$  for all  $v \in \mathfrak{a}$ . In particular,  $\delta(\check{\delta}) = 2$ , and when  $\delta$  is a root of maximal length, there is another root  $\alpha$  with  $\alpha(\check{\delta}) = 1$  as we read off from the root systems of rank  $\leq 2$ .

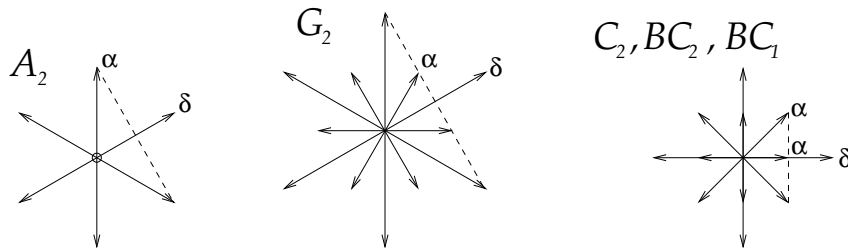

Along the closed geodesic  $\gamma(t) = \exp t\check{\delta}$ ,  $t \in [0, 1]$ , some Jacobi fields  $J$  with  $J(0) = 0$  vanish at  $t = \frac{1}{2}$ , others only at  $t = 1$  (when  $J'(0)$  lies in the root space of  $\delta$  or  $\alpha$ , respectively), and therefore the midpoint  $\gamma(\frac{1}{2})$  belongs to a polar. Since this was excluded, the root system of  $M''$  must be  $A_1 \times \dots \times A_1$ , and since  $M''$  is simply connected, it is a product of spheres. We have proved:

**Theorem 8.** *The maximal torus of a compact extrinsic symmetric space is the extrinsic product of planar circles.*

## 9. Isometries of ESS are extrinsic.

By definition of an extrinsic symmetric space  $M$ , all isometries which are generated by symmetries extend to the ambient space, in particular all transvections. But we claim more: *all* isometries of  $M$  extend to the ambient space.

For hermitian symmetric spaces this is not difficult to prove, see [9]. Such a space  $\hat{M} = G/H$  is embedded into the Lie algebra  $\mathfrak{g}$  of its own transvection group  $G$  as an adjoint orbit  $\text{Ad}_G x$ , where  $x \in \mathfrak{g}$  is the canonical generator of the center  $\mathbb{S}_x^1$  of  $H = G_x$ , see section 3. Let  $f$  be any isometry of  $\hat{M}$ . Replacing  $f$  by  $g \circ f$  for some  $g \in G$  if necessary, we may assume  $f(x) = x$ . The conjugation  $g \mapsto f g f^{-1}$  defines an orthogonal

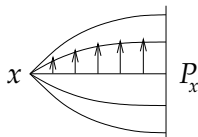

<sup>21</sup> A symmetric space is called *semisimple* if it has no flat local factor.

automorphisms  $\phi$  of the full isometry group and of its connected component  $G$ , and  $\phi$  preserves also the isotropy subgroup  $H$  of  $x$  since  $fhf^{-1}x = x$  for all  $h \in H$ . Thus its differential  $\phi_*$  is an orthogonal automorphism of  $\mathfrak{g}$  with  $\phi_*x = \pm x$  since  $\phi$  preserves  $\mathbb{S}_x^1$ . Further,

$$\begin{aligned}\phi_*(gx) &= \phi_* \text{Ad}_g x = \text{Ad}_{\phi(g)} \phi_* x = \pm \text{Ad}_{\phi(g)} x, \\ f(gx) &= fgf^{-1}x = \phi(g)x = \text{Ad}_{\phi(g)} x.\end{aligned}$$

This shows that  $\pm\phi_* : \mathfrak{g} \rightarrow \mathfrak{g}$  keeps  $\hat{M} \subset \mathfrak{g}$  invariant with  $\pm\phi_*|_{\hat{M}} = f$ .

One should be able to extend this proof to a non-hermitian extrinsic symmetric space  $M$  since this is a real form of a hermitian symmetric space  $\hat{M}$ . However, we cannot show directly that any isometry of  $M$  extends to an isometry of  $\hat{M}$ ; this follows only afterwards as a consequence of our theorem that all isometries are extrinsic.

We start as before. Given an isometry  $f$  of  $K/K_+ \cong M = \text{Ad}_K x \subset \mathfrak{p}$  fixing the base point  $x$ , we define an automorphism  $\phi$  of  $K$  preserving  $K_+$  (the isotropy group of  $x$ ) by putting  $\phi(k) = fkf^{-1}$ . But now  $\phi_*$  does not act on the ambient space  $\mathfrak{p}$  but on  $\mathfrak{k}$ . In fact we show that  $f$  can be extended to the ambient space  $\mathfrak{p}$  if and only if  $\phi_*$  extends to an automorphism of  $\mathfrak{g} = \mathfrak{k} + \mathfrak{p}$ . This extension exists when  $K$  is the transvection group of an extrinsic symmetric space in  $\mathfrak{p}$  as we have shown by a careful case-by-case study [11]. A classification-free argument is still missing.

Let us discuss just one example: the space  $M$  of real structures on  $\mathbb{C}^n$ ,  $n \geq 3$ , embedded in the space  $V = \mathfrak{p}$  of symmetric  $\mathbb{C}$ -antilinear maps on  $\mathbb{C}^n$ . We have  $M = K/K_+$  with  $K = U_n/\pm$  and  $K_+ = O_n/\pm$ , and  $P = G/K$  with  $G = Sp_n/\pm$ . We look for all automorphisms  $\phi$  of  $K$  which preserve  $K_+$  (“admissible automorphisms”) and ask if  $\phi_*$  extends to  $\mathfrak{g}$ . First we consider the covering group  $\tilde{K} = SU_n \times \mathbb{S}^1$ . The automorphisms of  $\tilde{K}$  have the form  $\tilde{\phi} = (\phi_1, \phi_2)$  with  $\phi_1 \in \text{Aut}(SU_n)$  and  $\phi_2 \in \text{Aut}(\mathbb{S}^1)$ . The Dynkin diagram of  $SU_n$  is the string  $A_{n-1}$  (see section 5) which has two diagram automorphisms, the identity and the reflection. Thus there are two classes of automorphisms of  $SU_n$  modulo inner automorphisms, represented by the identity  $\text{id}$  and the complex conjugation  $\kappa$ . Further,  $\mathbb{S}^1$  has only one nontrivial automorphism, complex conjugation  $\kappa$ . But in  $U_n$  the circle  $\mathbb{S}^1 = \{\lambda I : |\lambda| = 1\}$  intersects the subgroup  $SU_n$  at its center  $Z = \{\zeta^k I : k = 1, \dots, n\}$  where  $\zeta = e^{2\pi i/n}$ . Hence  $\tilde{\phi} = (\phi_1, \phi_2)$  descends to  $U_n/\pm$  if and only if  $\phi_1(\zeta I) = \pm\phi_2(\zeta)$ .

*Case 1.* When  $\phi_1$  is inner, the center is kept fixed, which forces  $\phi_2(\zeta) = \pm\zeta$ . Thus  $\phi_2 = \text{id}$  and  $\phi$  is inner, except in the case  $n = 4$  ( $\zeta = i$ ) where  $\phi_2 = \kappa$  is possible.

*Case 2.* When  $\phi_1 = \kappa$  modulo inner automorphisms, we must have  $\phi_2(\zeta) = \pm\bar{\zeta}$ , hence  $\phi_2 = \kappa$  and  $\phi = \kappa$  (unless  $n = 4$  when also  $\phi_2 = \text{id}$  is possible).

Inner automorphisms extend to any larger group, here to  $G = Sp_n/\pm$ , and also  $\kappa$  extends to  $Sp_n/\pm$  via the conjugation by  $jI$ . Alternatively, we may construct the extension of  $\kappa$  to the ambient space  $\mathfrak{p}$  directly as the conjugation  $X \mapsto \kappa X \kappa$  for any  $X \in \mathfrak{p}$  where  $\mathfrak{p}$  is the space of symmetric antilinear maps on  $\mathbb{C}^n$ .

Yet in the case  $n = 4$  there are “mixed” automorphisms on  $U_4/\pm$ , namely  $\phi : \pm A \mapsto \pm A/\sqrt{\det A}$  and its composition with  $\kappa$ . In fact,  $\phi_1 = \text{id}$  on  $SU_4$  and  $\phi_2 = \kappa$  on  $\mathbb{S}^1$  since  $\det(\phi(A)) = \det(A)/\sqrt{\det(A)^4} = 1/\det A = \kappa(\det A)$ . But  $\phi$  is not admissible, since it does not preserve  $K_+$  although it does preserve its identity component  $K_+^o = SO_4/\pm$ . But  $K_+$  has another component  $K_+^1 = \{\pm A : A \in O_4, \det A = -1\}$ , and this is not preserved by  $\phi$  as  $\sqrt{\det A}$  is no longer real. Likewise,  $\phi\gamma$  cannot preserve  $K_+$  for any inner automorphism  $\gamma(u) = gug^{-1}$  on  $U_4$ : otherwise,  $\gamma$  would preserve  $K_+^o$ , but then

(being a conjugation in  $U_4$ ) it would also preserve  $K_+$ , and consequently  $\phi\gamma$  would not preserve  $K_+$ , a contradiction.

Another example is very similar: the half-dimensional real Grassmannians  $G_n(\mathbb{R}^{2n}) = K/K_+$  with  $K = SO_{2n}/\pm$  and  $K_+ = S(O_n \times O_n)/\pm$  where  $P = G/K$  with  $G = U_{2n}/\pm$ . Again  $n = 4$  is problematic since  $SO_8/\pm$  has the *triality automorphism*  $\phi : \pm S_v S_w \mapsto \pm L_{\bar{v}} L_w$  where  $S_v$  denotes the reflection along the hyperplane  $v^\perp$  and  $L_w$  is the left multiplication with the octonion  $w \in \mathbb{R}^8 = \mathbb{O}$ . But as before,  $\phi$  is not admissible. It preserves the connected component  $K_+^o = (SO_4 \times SO_4)/\pm$  of  $K_+$ , but not the other component  $K_+^1 = \{\pm(A, B) : A, B \in O_4, \det A = \det B = -1\}$ . We obtain:

**Theorem 9.** *Every isometry of an extrinsic symmetric space extends to an isometry of the ambient space.*

## 10. ESS have a noncompact transformation group.

Extrinsic symmetric spaces  $M \subset V$  have yet another surprising feature: they are so called *R-spaces*, allowing for a noncompact transformation group which extends the isometry group. E.g. for  $M = \mathbb{S}^n \subset \mathbb{R}^{n+1}$  this is the Moebius group of conformal transformations, for  $M = G_p(\mathbb{K}^n) \subset S(\mathbb{K}^n)$  it is the group of linear transformations modulo its center,  $PGL(\mathbb{K}^n)$ . What is the relation between this noncompact group action and the extrinsic symmetric embedding? In the simplest example  $M = \mathbb{S}^n \subset \mathbb{R}^{n+1}$  this can be visualized.

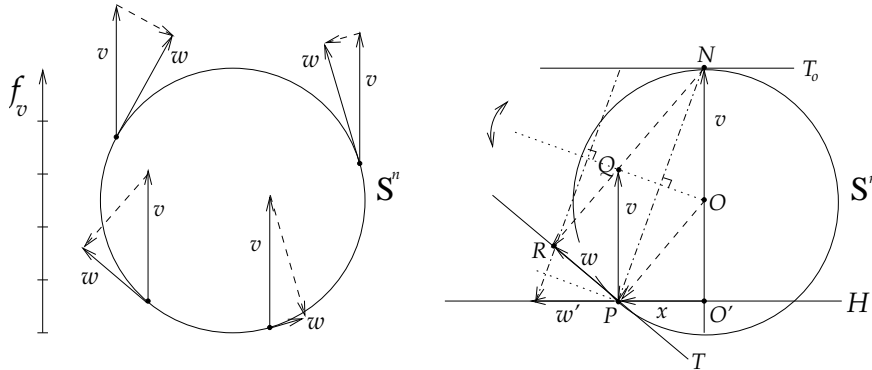

Consider the *height function*  $f_v : \mathbb{S}^n \rightarrow \mathbb{R}$ ,  $f_v(x) = \langle x, v \rangle$  for any fixed  $v \in \mathbb{R}^{n+1}$ , e.g.  $v = e_{n+1}$ . Its gradient at any point  $P \in \mathbb{S}^n$  is the projection  $w$  of  $v$  onto the tangent plane  $T = T_P \mathbb{S}^n$  (see left figure above). It is well known that the flow of this tangent vector field  $w$  consists of conformal diffeomorphisms of  $\mathbb{S}^n$ . This can be seen from the right figure which shows that  $w$  after stereographic projection from the north pole  $N = v$  becomes the identical vector field  $w'(x) = x$  on  $H = \mathbb{R}^n$ .<sup>22</sup> The flow of this vector field  $w'$  consists of the homotheties  $\phi_t(x) = e^t x$ . These are conformal maps, and since stereographic projection preserves conformality, the gradient flow on  $\mathbb{S}^n$  consists of conformal transformations too. The choice of  $v$  was arbitrary (for general nonzero  $v \in \mathbb{R}^{n+1}$  we choose  $N = v/|v|$  as north pole). Thus we obtain an  $(n + 1)$ -parameter

<sup>22</sup>The vector  $w = \vec{PR}$  is the orthogonal projection of  $v$  onto the tangent hyperplane  $T$  at  $P \in \mathbb{S}^n$ . Stereographic projection  $\Phi$  from  $N$  maps  $\mathbb{S}^n \setminus \{N\}$  onto an affine hyperplane  $H \perp N$ . We may assume  $P \in H$ . Then  $w' = \Phi_* w$  is the projection of  $w$  onto  $H$  along the projection line  $NP$ . Choose  $O' = H \cap \mathbb{R}N$  as the origin of  $H$ . Let  $x = \vec{O'P}$ . Since the quadrangle  $NOPQ$  is a rhomb ( $NQ \parallel OP$ ), the rectangular triangles  $PRN$  and  $PO'N$  are congruent, hence  $|w| = |x|$ . Since the projection line  $NP$  is perpendicular to the bisector (dotted line) between the tangent hyperplanes  $T_o$  in  $N$  and  $T$  in  $P$ , we have  $|w'| = |w|$ . Thus  $|w'| = |w| = |x|$  and hence  $w' = x$  since  $w'$  and  $x$  are pointing to the same direction.



family of nonisometric conformal diffeomorphisms, and together with the orthogonal group we have  $n + 1 + \frac{1}{2}n(n + 1) = \frac{1}{2}(n + 1)(n + 2)$  parameters; this number is the dimension of the Moebius group (which is the Lorentz group in  $\mathbb{R}^{n+2}$ ).

This is true in general [13]: for any extrinsic symmetric space  $M \subset \mathfrak{p}$ , the gradient flows of the height functions  $f_v(x) = \langle x, v \rangle$ ,  $v \in \mathfrak{p}$ , generate a noncompact group  $G^* \supset K$  acting on  $M$  and extending the  $K$ -action, and the Lie algebra of  $\mathfrak{g}^*$  has the vector space decomposition  $\mathfrak{g}^* = \mathfrak{k} \oplus \mathfrak{p}$ . However, this is not the Lie algebra  $\mathfrak{g}$  of the group  $G$  introduced in sections 4 and 6 since  $G^*$  is noncompact. In fact,  $K \subset G^*$  is the maximal compact subgroup, and the symmetric space  $P^* = G^*/K$  is the noncompact dual of  $P = G/K$  where the Lie bracket on  $\mathfrak{p}$  is changed by a sign:  $[v, w]^* := -[v, w]$ . This new Lie triple will be denoted  $\mathfrak{p}^*$  or  $i\mathfrak{p}$  (where  $i = \sqrt{-1}$ ).

Let us first describe the action of  $G^*$  on  $M$ . Let  $x \in M \subset \mathfrak{p}^*$  be fixed. As before,  $\mathfrak{h}^* := \ker \text{ad}_x = \mathfrak{k}_+ + N$  (where  $N = N_x M$  is the normal space) is the Lie algebra of the isotropy group  $H^*$  of  $x$  under the adjoint action of  $G^*$  on  $\mathfrak{g}^*$ ,

$$H^* = \{g \in G^* : \text{Ad}_g x = x\}. \quad (11)$$

Moreover,  $\text{ad}_x$  maps  $T = T_x M \subset \mathfrak{p}$  onto  $\mathfrak{k}_- = \mathfrak{k} \cap (\cdot^*)$  and vice versa, but this time we have  $(\text{ad}_x)^2 = I$  on  $T + \mathfrak{k}_-$  (instead of  $(\text{ad}_x)^2 = -I$ ), due to the sign change of the Lie bracket on  $\mathfrak{p}^*$ . Thus we have an eigenspace decomposition<sup>23</sup>

$$\mathfrak{g}^* = \mathfrak{n}_- \oplus \mathfrak{h}^* \oplus \mathfrak{n}_+ \quad (12)$$

where  $\text{ad}_x = \pm I$  on  $\mathfrak{n}_\pm$  and  $\text{ad}_x = 0$  on  $\mathfrak{h}^*$ . Let  $\sigma \in \text{Aut}(\mathfrak{g}^*)$  be the involution corresponding to the symmetric pair  $(\mathfrak{g}^*, \mathfrak{k})$  (that is  $\sigma = I$  on  $\mathfrak{k}$  and  $\sigma = -I$  on  $\mathfrak{p}^*$ ). Then  $\sigma x = -x$  and hence  $\sigma \mathfrak{n}_\pm = \mathfrak{n}_\mp$  while  $\sigma \mathfrak{h}^* = \mathfrak{h}^*$ . Let

$$Q = \{g \in G^* : \text{Ad}_g(x + \mathfrak{n}_-) = x + \mathfrak{n}_-\}. \quad (13)$$

**Lemma.**  $Q$  is a subgroup of  $G^*$  with  $H^* \subset Q$ , and its Lie algebra  $\mathfrak{q}$  contains  $\mathfrak{h}^* + \mathfrak{n}_-$ . Moreover,  $K \cap Q = K_+$  where  $K_+ = \{k \in K : kx = x\}$ .

*Proof.* Let  $h \in H^*$ , that is  $\text{Ad}_h x = x$  (see (11)). Thus  $\text{Ad}_h$  commutes with  $\text{ad}_x$ :

$$\text{Ad}_h \text{ad}_x y = \text{Ad}_h[x, y] = [\text{Ad}_h x, \text{Ad}_h y] = [x, \text{Ad}_h y] = \text{ad}_x \text{Ad}_h y.$$

Hence  $\text{Ad}(h)$  preserves the eigenspaces of  $\text{ad}_x$  and in particular  $\text{Ad}_h(x + \mathfrak{n}_-) = x + \mathfrak{n}_-$ . This implies  $h \in Q$ , see (13). Hence  $\mathfrak{h}^* \subset \mathfrak{q}$ . But also  $\mathfrak{n}_- \in \mathfrak{q}$ . To show this, we pick  $z \in \mathfrak{n}_-$ . Clearly,  $\text{Ad}_{\exp z} \mathfrak{n}_- = \mathfrak{n}_-$ , and

$$\text{Ad}_{\exp z} x = e^{\text{ad}_z} x = x + \text{ad}_z x + \frac{1}{2}(\text{ad}_z)^2 x + \cdots = x + z \in x + \mathfrak{n}_-$$

since  $\text{ad}_z x = -[x, z] = z$  and  $\text{ad}_z(\text{ad}_z x) = \text{ad}_z z = 0$ . Thus  $\exp z \in Q$  and  $z \in \mathfrak{q}$ .

Further, for all  $k \in K \cap Q$  we have  $x + \mathfrak{n}_- = k(x + \mathfrak{n}_-) = kx + k\mathfrak{n}_-$ , hence  $k\mathfrak{n}_- = \mathfrak{n}_-$  and  $kx \in x + \mathfrak{n}_-$ . Thus  $kx - x \in \mathfrak{p}^* \cap \mathfrak{n}_- = \{0\}$  whence  $kx = x$ , so  $k \in K_+$ . We have shown  $K \cap Q \subset K_+$ . Vice versa,  $K_+ \subset K \cap Q$  since  $K_+ \subset H^* \subset Q$ .  $\square$

<sup>23</sup>This was the starting point in the earliest paper on this subject, [18]

We let  $K \subset G^*$  act by left multiplication on the coset space  $M' := G^*/Q$ . Its Lie algebra is

$$\mathfrak{k} = \text{Fix}(\sigma) = \mathfrak{h}^* \cap \mathfrak{k} + (\mathfrak{n}_+ + \mathfrak{n}_-) \cap \mathfrak{k} = \mathfrak{k}_+ + \{v + \sigma v : v \in \mathfrak{n}_+\}.$$

Then  $\mathfrak{k} + \mathfrak{q} \supset \mathfrak{k} + \mathfrak{h}^* + \mathfrak{n}_- = \{v + \sigma v : v \in \mathfrak{n}_+\} + \mathfrak{h}^* + \mathfrak{n}_- = \mathfrak{g}^*$ , hence  $K \subset G^*$  is transversal to  $Q$  and thus the  $K$ -orbit of  $eQ \in G^*/Q = M'$  is open. But  $K$  is compact, therefore the  $K$ -orbit is also closed and  $K$  acts transitively on  $G^*/Q$ . Its isotropy group at  $eQ$  is  $K \cap Q = K_+$  (see the lemma above), thus  $M' = K/K_+ = M$  where  $eQ \in M'$  becomes  $x \in M$ .

Now we show that this action of  $G^*$  on  $M$  is generated by the negative gradient flows of the height functions  $f_v$ . Let  $v \in \mathfrak{p}^*$  and  $x \in M \subset \mathfrak{p}^*$ . We have  $v = v_N + v_T$  with  $v_N \in N = \mathfrak{p}^* \cap \mathfrak{h}^*$  and  $v_T \in T = \mathfrak{p}^* \cap (\mathfrak{n}_+ + \mathfrak{n}_-)$ . Using  $\sigma = -I$  on  $\mathfrak{p}^*$  we can put  $v_T = v_+ - \sigma v_+$  for some  $v_+ \in \mathfrak{n}_+$ . Let us denote  $w.x := \left. \frac{d}{dt} \right|_{t=0} \exp(tw)x$  for any  $w \in \mathfrak{g}^*$  and  $x \in M$  (infinitesimal action). Then  $v.x = (v_+ - \sigma v_+).x = (v_+ + \sigma v_+).x$  since  $v_N \in \mathfrak{h}^* \subset \mathfrak{q}$  and  $\sigma v_+ \in \mathfrak{n}_- \subset \mathfrak{q}$ . But  $v_+ + \sigma v_+ \in \mathfrak{k}$  and hence  $(v_+ + \sigma v_+).x = [v_+ + \sigma v_+, x] = -\text{ad}_x(v_+ + \sigma v_+) = -(v_+ - \sigma v_+) = -v_T$ . Thus

$$v.x = -v_T = -\nabla f_v(x). \quad (14)$$

There is yet another model for this  $G^*$ -action, see [7] for details. The symmetric space  $P^* = G^*/K$  is a Hadamard manifold (simply connected, sectional curvature  $\leq 0$ ) which can be compactified by the Eberlein-O'Neill boundary. The ideal boundary points (points at infinity) are the equivalence classes  $[\gamma] = \gamma(\infty)$  of geodesic rays  $\gamma$  where two geodesic rays are called equivalent when they have bounded distance. The set of all ideal points is called the *ideal boundary*  $P^*(\infty)$  on which the isometry group  $G^*$  of  $P^*$  acts naturally. For any  $p \in P^*$  and every  $\omega \in P^*(\infty)$  there is exactly one geodesic ray  $\gamma$  with  $\gamma(0) = p$  with  $\gamma(\infty) = \omega$ . This defines a homeomorphism  $\psi_p : \mathbb{S}_p P^* \rightarrow P^*(\infty)$  (where  $\mathbb{S}_p P^*$  is the unit sphere in  $T_p P^*$ ) sending  $v \in \mathbb{S}_p P^*$  to  $\gamma_v(\infty)$ , and  $\psi_p$  is equivariant with respect to the isotropy group  $G_p^* \subset G^*$ . In particular this is true for the base point  $o = eK$  where  $G_o^* = K$ . Further,  $\xi = \psi_o(x) \in P^*(\infty)$  is fixed by  $Q = H^*N_-$  with  $N_- = \exp(\mathfrak{n}_-)$ . Since  $\mathfrak{g}^* = \mathfrak{k} + \mathfrak{h} + \mathfrak{n}_- = \mathfrak{k} + \mathfrak{q}$  (with  $\mathfrak{k} \cap \mathfrak{q} = \mathfrak{k}_+$ ) and  $G^* = KQ$ , the orbits  $G^*\xi$  and  $K\xi$  on  $P^*(\infty)$  are the same,  $G^*\xi = KQ\xi = K\xi$ .<sup>24</sup>

**Theorem 10.** *Let  $M \subset \mathfrak{p}$  be extrinsic symmetric with transvection group  $K$ . Let  $G^*$  be the (noncompact) Lie group containing  $K$  and with Lie algebra  $\mathfrak{g}^* = \mathfrak{k} + i\mathfrak{p}$ . Then there is an action of  $G^*$  on  $M$  extending the action of  $K$ , and this action is generated by the (negative) gradient flows of the height functions on  $\mathfrak{p}$ .*

**Problem.** *For every extrinsic symmetric space  $M$ , describe the non-metric geometry on  $M$  whose automorphism group is  $G^*$ .*

For  $M = \mathbb{S}^n$  this is conformal geometry, for  $M = \mathbb{R}\mathbb{P}^n$  it is projective geometry. The non-metric geometry has been used in [5] for surface theory on  $M$ . General answers have been given in [29, 15, 4].

## 11. ESS contain their noncompact duals.

The hyperbolic plane has two classical models: Poincaré and Klein. In both cases, the underlying set is the open unit disk  $\mathbb{D}^2$ , but while in the Klein model the geodesics are

<sup>24</sup>This is true even for arbitrary  $\xi \in P^*(\infty)$  by the Iwasawa decomposition of  $G^*$ .

line segments, in the Poincaré model they are orthocircles, circular arcs perpendicular to the boundary circle.

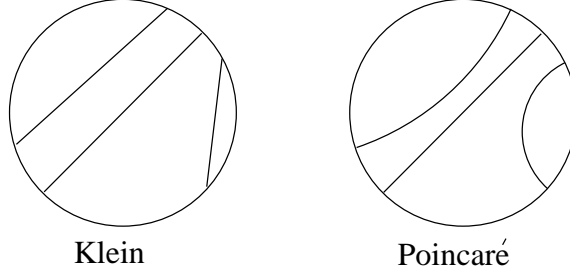

There is a deeper reason for the two models: The hyperbolic plane  $H^2$  is dual to two different extrinsic symmetric spaces: projective plane  $\mathbb{RP}^2$  and the sphere  $\mathbb{S}^2$ . According to a theorem of Nagano [22], every extrinsic symmetric space  $M$  contains its noncompact dual space  $M^*$ , and the isometry group of  $M^*$  becomes a subgroup of the noncompact transformation group  $G^*$  on  $M$ . Thus  $H^2$  is embedded as  $\mathbb{D}^2 \subset \mathbb{R}^2 \subset \mathbb{RP}^2$  into  $\mathbb{RP}^2$  (Klein model) and as the upper hemisphere into  $\mathbb{S}^2$  with its conformal group preserving circles and angles (Poincaré model). Nagano's equivariant embedding  $M^* \subset M$  can be easily seen as follows.

Let  $M = K/K_+ \subset \mathfrak{p}$  be extrinsic symmetric where  $\mathfrak{p}$  belongs to the symmetric space  $P = G/K$ . The Lie algebra of  $G$  decomposes as

$$\mathfrak{g} = \mathfrak{k} + \mathfrak{p} = \mathfrak{k}_+ + \mathfrak{k}_- + T + N$$

where  $\text{ad}_{\mathfrak{k}_+}$  leaves all four summands invariant, and  $\mathfrak{k}_-$ ,  $T$  and  $N$  are Lie triples with brackets in  $\mathfrak{k}_+$  while  $[T, N] \subset \mathfrak{k}_-$  and  $[T, \mathfrak{k}_-] \subset N$ , see (6), (8) in section 4. Further,  $\text{ad}_x$  vanishes on  $\mathfrak{k}_+ + N$ , and it interchanges  $\mathfrak{k}_-$  and  $T$  with  $(\text{ad}_x)^2 = -I$  on  $\mathfrak{k}_- + T$ . Since  $\text{ad}_x$  is a derivation, it follows for all  $v, w \in T$

$$[\text{ad}_x v, \text{ad}_x w] = \text{ad}_x[v, \text{ad}_x w] - [v, (\text{ad}_x)^2 w] = [v, w]$$

since  $[v, \text{ad}_x w] \in [T, \mathfrak{k}_-] \subset N \subset \ker \text{ad}_x$ . Therefore  $\mathfrak{k}_+ + T$  is a subalgebra isomorphic to  $\mathfrak{k}$  (while  $\mathfrak{k}_+ + N = \mathfrak{h}$  is the Lie algebra of the isotropy group  $H$  of the hermitian symmetric space  $\text{Ad}_G x$ ).

The large symmetric space  $P = G/K$  has the dual space  $P^* = G^*/K$  where the Lie algebra of  $G^*$  is  $\mathfrak{g}^* = \mathfrak{k} + i\mathfrak{p}$ . Let  $\mathfrak{k}^* = \mathfrak{k}_+ + iT \subset \mathfrak{g}^*$  and  $K^* \subset G^*$  the connected subgroup with Lie algebra  $\mathfrak{k}^*$ . Then  $M^* = K^*/K_+$  is the dual space of  $M$ . This is embedded into  $M = Kx = G^*x$  as  $K^*x \subset G^*x$ , and  $K^*x$  is an open subset in  $M$  since  $T_x(K^*x) = \mathfrak{k}^*.x \cong \mathfrak{k}^*/\mathfrak{k}_+$  has the same dimension as  $T_x M = \mathfrak{k}.x \cong \mathfrak{k}/\mathfrak{k}_+$ . Thus:

**Theorem 11.** *Let  $M = K/K_+$  be an extrinsic symmetric space with noncompact transformation group  $G^*$ . Then there is an  $K^*$ -equivariant embedding  $M^* \subset M$  as an open subset.*

**Conjecture.**  $K^* = \{g \in G^* : g(M^*) = M^*\}$ .

*The conjecture is true for conformal and projective geometry.*

## 12. ESS in symmetric spaces come from ESS in euclidean space.

Let  $P$  be any Riemannian symmetric space. A submanifold  $M \subset P$  is called *extrinsic symmetric* if for any  $x \in M$  there is an isometry  $r_x$  of  $P$  fixing  $x$  such that  $(r_x)_*$  on  $T_x P$  is the reflection along  $N_x M$  and  $r_x(M) = M$ . Totally geodesic extrinsic

symmetric subspaces are just reflective subspaces. For the non-totally geodesic ones the case  $\text{rank}(P) = 1$  is different, see [1] and the references within. For higher rank, the non-totally geodesic extrinsic symmetric spaces have been classified in [23] for the compact case and in [3] for the noncompact case.

**Theorem 12.** *Let  $P$  be an irreducible symmetric space of rank  $\geq 2$ . If  $P$  is compact and  $M \subset P$  extrinsic symmetric but not totally geodesic, then  $M$  is congruent to  $\exp_o M_o$  for some extrinsic symmetric space  $M_o \subset \mathfrak{p} = T_o P$ . If  $P$  is noncompact, there is an analogous result, but allowing also for noncompact  $M$ .*

The proof uses a series of long papers by Naitoh, see references in [23, 1]. Here we sketch only a partial case with a short classification-free proof [8]. If  $M \subset P$  is extrinsic symmetric and  $r_x$  the extrinsic reflection at some  $x \in M$ , there is a reflective subspace  $M' \subset P$  through  $x$  with  $T_x M' = T_x M$ . It is the fixed point component through  $x$  of the involution  $s_x r_x$  where  $s_x$  denotes the symmetry of  $P$  at  $x$ . We make the additional assumption that  $M'$  is irreducible of rank  $\geq 2$  (or all its local factors have rank  $\geq 2$ ). Then we can use the following consequence of Berger-Simons' holonomy theorem [2]:

**Lemma.** *Every irreducible holonomy group  $H$  is a maximal subgroup of some linear group which acts transitively on the unit sphere.*

**Proof.** If  $(V, R, H)$  is a *holonomy system*, that is  $R$  is an algebraic curvature tensor on some euclidean vector space  $V$  with  $R(v, w) \in \mathfrak{h}$  for all  $v, w \in V$ , then  $(V, R, H')$  is again a holonomy system for any compact linear group  $H' \supset H$  on  $V$ . If  $H$  acts irreducibly, then so does  $H'$ , and if  $H'$  does *not* act transitively on  $S_V$ , then according to Simons' theorem,  $(V, R, H')$  is a *symmetric* holonomy system which means that  $H'$  preserves the curvature tensor  $R$ . Then  $(V, R)$  is a Lie triple system,  $R(v, w) = [v, w]$ . We have  $\{[v, w] : v, w \in V\} \subset \mathfrak{h} \subset \mathfrak{h}'$ , but if  $A \in \mathfrak{h}'$  is perpendicular to all  $[v, w]$ , then  $0 = \langle A, [v, w] \rangle = \langle Av, w \rangle$  for all  $v, w \in V$  and therefore  $A = 0$ . Thus  $\mathfrak{h} = \mathfrak{h}'$ .  $\square$

Now we observe that the curvature tensor  $R^P$  of the ambient space which is parallel for the connection  $D$  on  $P$  is also parallel for the induced connection  $\nabla$  on  $TM$ . In fact, if we consider parallel tangent vector fields  $a, b, c, d$  along some curve on  $M$ , the derivative of the expression  $\langle R^P(a, b)c, d \rangle$  vanishes since  $\langle R^P(a, b)c, d \rangle' = \langle R^P(a', b)c, d \rangle + \dots$  where  $a'$  denotes the  $D$ -derivative along the curve. By  $\nabla$ -parallelity,  $a'$  is normal and hence  $\langle R^P(a', b)c, d \rangle = 0$  since the restriction of  $R^P$  to  $T_x M$  is a Lie triple (it is the curvature tensor of  $M'$ ). The same holds for the omitted three terms. Let  $H$  and  $H'$  be the identity components of the isotropy groups (= holonomy groups) of  $M$  and  $M'$ . Since  $R^P|_{TM}$  is  $\nabla$ -parallel, it is fixed under  $H$ . Thus  $H \subset H'$  since  $H'$  is the identity component of the automorphism group of  $R^P|_{T_x M}$ . Using our rank assumption and the lemma above we obtain  $H = H'$  and thus  $R^M = \lambda R^P|_{T_x M}$  for some constant  $\lambda \neq 0$ . Thus the Gauss equations  $R^M - R^P = \alpha \wedge \alpha$  look essentially like the euclidean ones,  $R^M = \alpha \wedge \alpha$ . A similar argument holds for Codazzi and Ricci equations. Using the existence theorem for submanifolds we thus obtain an equivariant embedding  $M_o$  of  $M$  into the euclidian space  $\mathfrak{p} = T_o P$  which is extrinsic symmetric. Comparing the parameters we see from the congruence theorem in  $P$  that  $M \cong \exp_o(tM_o)$  for some  $t$ .

## References

- [1] J. Berndt: *Symmetric submanifold of symmetric spaces*, Taegu, Korea, 2002, <http://www.mth.kcl.ac.uk/~berndt/taegu02.pdf>
- [2] J. Berndt, S. Console, C. Olmos: *Submanifolds and holonomy*, Chapman & Hall 2003

- [3] J. Berndt, J.-H. Eschenburg, H. Naitoh, K. Tsukada: Symmetric submanifolds associated with irreducible symmetric R-spaces, *Math. Ann.* 332 (2005), 721 - 737
- [4] W. Bertram: *Un théorème de Liouville pour les algèbres de Jordan*, *Bull. Soc. Math. France* 124 (1996), 299 - 327
- [5] F.E. Burstall, N. M. Donaldson, F. Pedit, U. Pinkall: *Isothermic submanifolds of symmetric R-spaces*. *J. Reine Angew. Math.* 660 (2011), 191-243, <http://arxiv.org/pdf/0906.1692.pdf>
- [6] B.-Y. Chen and T. Nagano: *Totally geodesic submanifolds of symmetric spaces, II*, *Duke Math. J.* 45 (1978), 405 - 425
- [7] P. Eberlein: *Manifolds of Nonpositive Curvature*, Chicago University Press 1996
- [8] J.-H. Eschenburg: *Higher rank curved Lie triples*, *J. Math. Soc. Jap.* 54 (2002), 551 - 564
- [9] J.-H. Eschenburg, P. Quast, M.S. Tanaka: *Isometries of Hermitian Symmetric Spaces* *J. of Lie Theory* 23 (2013), 113 - 118
- [10] J.-H. Eschenburg, P. Quast, M.S. Tanaka: *Maximal tori of extrinsic symmetric spaces and meridians*, *Osaka J. Math.* 52 (2015), 299 - 307
- [11] J.-H. Eschenburg, P. Quast, M.S. Tanaka: *Isometries of extrinsic symmetric spaces*, Preprint Augsburg 2014, submitted to *Math. Ann.*
- [12] J.-H. Eschenburg, E. Heintze: *Extrinsic symmetric spaces and orbits of s-representations*, *manuscripta math.* 88 (1993), 517 - 524
- [13] J.-H. Eschenburg, A.L. Mare: *Steepest descent on real flag manifolds*, *Bull. London Math. Soc.* 38 (2006), 323 - 328
- [14] D. Ferus: *Immersions with parallel second fundamental form*, *Math. Z.* 140 (1974), 87 - 93, *Symmetric submanifolds of euclidean space*, *Math. Ann.* 247 (1980), 81 - 93
- [15] S. Gindikin, S. Kaneyuki: *On the automorphism group of the generalized conformal structure of a symmetric R-space*, *Diff. Geom. and its Appl.* 8 (1998) 21-33
- [16] O. Ikawa, M.S. Tanaka, H. Tasaki: *The fixed point set of a holomorphic isometry, the intersection of two real forms in a Hermitian symmetric space of compact type and symmetric triads*, *Int. J. of Math.* 26 (2015), 1541005, 1 - 32
- [17] J.R. Kim, J.-H. Eschenburg: *Indefinite extrinsic symmetric spaces*, *manuscripta math.* 135 (2011), 203 - 214
- [18] S. Kobayashi, T. Nagano: *On Filtered Lie Algebras and Geometric Structures I*, *J. Math. Mech.* 13 (1964), 875 - 907
- [19] O. Loos: *Charakterisierung symmetrischer R-Räume durch ihre Einheitsgitter*, *Math. Z.* 189 (1985), 211-226
- [20] A.L. Mare, P. Quast: *On some spaces of minimal geodesics in Riemannian symmetric spaces*, *Quar. J. Math.* 63 (2012), 681 - 694
- [21] J. Milnor: *Morse Theory*. Princeton 1964.
- [22] T. Nagano: *Transformation groups on compact symmetric spaces*, *Trans. Am. Math. Soc.* 118 (1965), 428 - 453, <http://www.ams.org/journals/tran/1965-118-00/S0002-9947-1965-0182937-8/S0002-9947-1965-0182937-8.pdf>
- [23] H. Naitoh: *Symmetric submanifolds of compact symmetric spaces*, *Tsukuba J. Math.* 10 (1986), 215 - 241
- [24] P. Quast: *Complex structures and chains of symmetric spaces*, Habilitationsschrift, Augsburg 2010
- [25] P. Quast: *Centrioles in Symmetric Spaces*, *Nagoya Math. J.* 211 (2013), 51 - 77
- [26] P. Quast, M. Tanaka: *On the geometry of symmetric R-spaces*, <http://www.kurims.kyoto-u.ac.jp/kyodo/kokyuroku/contents/pdf/1929-06.pdf>

- [27] W. Strübing: *Symmetric submanifolds of Riemannian manifolds*, Math. Ann. 245 (1979), 37 - 44
- [28] M. Takeuchi: *Stability of certain minimal submanifolds of compact hermitian symmetric spaces*, Tohoku Math. J. 36 (1984), 293 - 314
- [29] M. Takeuchi: *Basis transformation of symmetric R-spaces*, Osaka J. Math. 25 (1988), 259 - 297
- [30] M.S. Tanaka: *Geometry of Symmetric R-spaces*, Progr. in Math. 308 (2015), 471 - 481